

FM Stereo FM/AM Receiver

Operating Instructions

Owner's Record

The model and serial numbers are located on the rear of the unit. Record the serial number in the space provided below. Refer to them whenever you call upon your Sony dealer regarding this product.

Model No. _____ Serial No. _____

***STR-DA5000ES
STR-DA3000ES***

WARNING

To prevent fire or shock hazard, do not expose the unit to rain or moisture.

To prevent fire, do not cover the ventilation of the apparatus with news papers, table-cloths, curtains, etc. And don't place lighted candles on the apparatus.

To prevent fire or shock hazard, do not place objects filled with liquids, such as vases, on the apparatus.

Do not install the appliance in a confined space, such as a bookcase or built-in cabinet.



Don't throw away batteries with general house waste; dispose of them correctly as chemical waste.

For customers in the United States

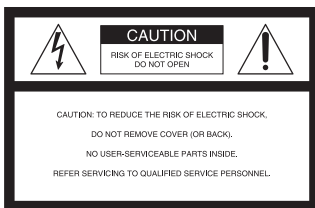

This symbol is intended to alert the user to the presence of uninsulated "dangerous voltage" within the product's enclosure that may be of sufficient magnitude to constitute a risk of electric shock to persons.



This symbol is intended to alert the user to the presence of important operating and maintenance (servicing) instructions in the literature accompanying the appliance.

WARNING

This equipment has been tested and found to comply with the limits for a Class B digital device, pursuant to Part 15 of the FCC Rules. These limits are designed to provide reasonable protection against harmful interference in a residential installation. This equipment generates, uses, and can radiate radio frequency energy and, if not installed and used in accordance with the instructions, may cause harmful interference to radio communications. However, there is no guarantee that interference will not occur in a particular installation. If this equipment does cause harmful interference to radio or television reception, which can be determined by turning the equipment off and on, the user is encouraged to try to correct the interference by one or more of the following measures:

- Reorient or relocate the receiving antenna.
- Increase the separation between the equipment and receiver.
- Connect the equipment into an outlet on a circuit different from that to which the receiver is connected.
- Consult the dealer or an experienced radio/TV technician for help.

CAUTION

You are cautioned that any changes or modification not expressly approved in this manual could void your authority to operate this equipment.

Note to CATV system installer:

This reminder is provided to call CATV system installer's attention to Article 820-40 of the NEC that provides guidelines for proper grounding and, in particular, specifies that the cable ground shall be connected to the grounding system of the building, as close to the point of cable entry as practical.

For customer in Canada

CAUTION

TO PREVENT ELECTRIC SHOCK, MATCH WIDE BLADE OF PLUG TO WIDE SLOT, FULLY INSERT.

Except for European model



ENERGY STAR® is a U.S. registered mark. As an ENERGY STAR® partner, Sony Corporation has determined that this product meets the ENERGY STAR® guidelines for energy efficiency.

About This Manual

- The instructions in this manual are for model STR-DA5000ES and STR-DA3000ES. Check your model number by looking at the lower right corner of the front panel. In this manual, STR-DA3000ES (area code CEL) is used for illustration purposes unless stated otherwise. Any difference in operation is clearly indicated in the text, for example, "STR-DA5000ES only".
- The instructions in this manual describe the controls on the receiver. You can also use the controls on the supplied remote if they have the same or similar names as those on the receiver. For details on the use of your remote, see the separate operating instructions supplied with the remote.
 - STR-DA5000ES
RM-LJ312
 - STR-DA3000ES
RM-LG112
 - STR-DA5000ES/STR-DA3000ES
Models of area code U,CA only
RM-US106

About area codes

The area code of the receiver you purchased is shown on the upper left portion of the rear panel (see the illustration below).

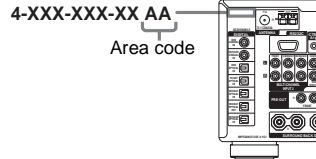

Any differences in operation, according to the area code, are clearly indicated in the text, for example, "Models of area code AA only".

This receiver incorporates Dolby* Digital and Pro Logic Surround and the DTS** Digital Surround System.

* Manufactured under license from Dolby Laboratories.

"Dolby", "Pro Logic" and the double-D symbol are trademarks of Dolby Laboratories.

** "DTS", "DTS-ES Extended Surround", and "Neo:6" are trademarks of Digital Theater Systems, Inc.

Table of Contents

Getting Started

- 1: Check how to hookup your components.....6
 - 1a: Connecting components with digital audio output jacks 8
 - 1b: Connecting components with multi channel output jacks..... 11
 - 1c: Connecting components with only analog audio jacks 13
- 2: Connecting the antennas 15
- 3: Connecting speakers 16
- 4: Connecting the AC power cord 18
- 5: Setting up the speakers 19
- 6: Adjusting the speaker levels and balance22
 - TEST TONE

Amplifier Operation

- Selecting the component 24
- Listening to multi channel sound 25
 - MULTI CH IN
- Listening to FM/AM radio 25
- Storing FM stations automatically 27
 - AUTOBETICAL
(Models of area code CEL only)
- Presetting radio stations 27
- Using the Radio Data System (RDS).... 28
(Models of area code CEL only)
- Changing the display..... 30
- About the indications in the display..... 31

Enjoying Surround Sound

- Using only the front speakers 33
- Enjoying higher fidelity sound..... 33
 - AUTO FORMAT DIRECT
- Selecting a sound field 34
- Selecting the surround back decoding mode 36
 - SURR BACK DECODING

Advanced Adjustments and Settings

- Assigning the audio input 38
 - DIGITAL ASSIGN

- Switching the audio input mode for digital components..... 39
 - INPUT MODE
- Customizing sound fields 39
- Adjusting the equalizer 41
- Advanced settings..... 42
- Custom install mode 47
(Models of area code U, CA only)
- Storing the adjusted settings 48
 - USER PRESET

Other Operations

- Naming preset stations and inputs 49
- Using the Sleep Timer 50
- Selecting the speaker system 50
- Recording 51
- Listening to the sound in another zone 52
(Models of area code U, CA only)
- CONTROL A1II Control System 54

Additional Information

- Precautions 56
- Troubleshooting..... 57
- Specifications 60
- List of button locations and reference pages..... 64
- Index 66

1: Check how to hookup your components

Steps 1a through 1c beginning on page 8 describe how to hook up your components to this receiver. Before you begin, refer to “Connectable components” below for the pages which describe how to connect each component.

After hooking up all your components, proceed to “2: Connecting the antennas” (page 15).

Connectable components

Component to be connected	Page
DVD player	
With digital audio output ^{a)}	8–9
With multi-channel audio output ^{b)}	11–12
With analog audio output only ^{c)}	8–9
TV monitor	
With component video input ^{d)}	9 or 12
With S-Video or composite video input only	14
Satellite tuner	
With digital audio output ^{a)}	8–9
With analog audio output only ^{c)}	8–9
CD/Super Audio CD player	
With digital audio output ^{a)}	10
With multi-channel audio output ^{b)}	11
With analog audio output only ^{c)}	13
MD/DAT deck	
With digital audio output ^{a)}	10
With analog audio output only ^{c)}	13
Tape deck, Analog disc turntable	13
Multi-channel decoder	11
VCR, video camera, video game, etc.	14

^{a)} Model with a DIGITAL OPTICAL OUTPUT or DIGITAL COAXIAL OUTPUT jack, etc.

^{b)} Model with MULTI CH OUTPUT jacks, etc. This connection is used to output the audio decoded by the component's internal multi-channel decoder through this receiver.

^{c)} Model equipped only with AUDIO OUT L/R jacks, etc.

^{d)} Model with component video (Y, P_B/C_B/B-Y, P_R/C_R/R-Y) input jacks.

Required cords

The hookup diagrams on the subsequent pages assume the use of the following optional connection cords (**A** to **H**) (not supplied).

A Audio cord

White (L)
Red (R)



B Audio/video cord

Yellow (video)
White (L/audio)
Red (R/audio)



C Video cord

Yellow



D S-video cord



E Optical digital cord



F Coaxial digital cord



G Monaural audio cord

Black



Tip

Audio cord **A** can be torn into two monaural audio cords **G**.

H Component video cord

Green
Blue
Red

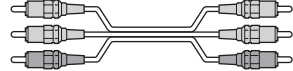

Notes

- Turn off the power to all components before making any connections.
- Be sure to make connections firmly to avoid hum and noise.
- When connecting an audio/video cord, be sure to match the color-coded pins to the appropriate jacks on the components: yellow (video) to yellow; white (left, audio) to white; and red (right, audio) to red.
- When connecting optical digital cords, insert the cord plugs straight in until they click into place.
- Do not bend or tie optical digital cords.

If you have Sony components with CONTROL A1II/CONTROL S jacks

See “CONTROL A1II Control System” on page 54.

1a: Connecting components with digital audio output jacks

Hooking up a DVD player, TV monitor, or satellite tuner

For details on the required cords (A–H), see page 7.

1 Connect the audio jacks.

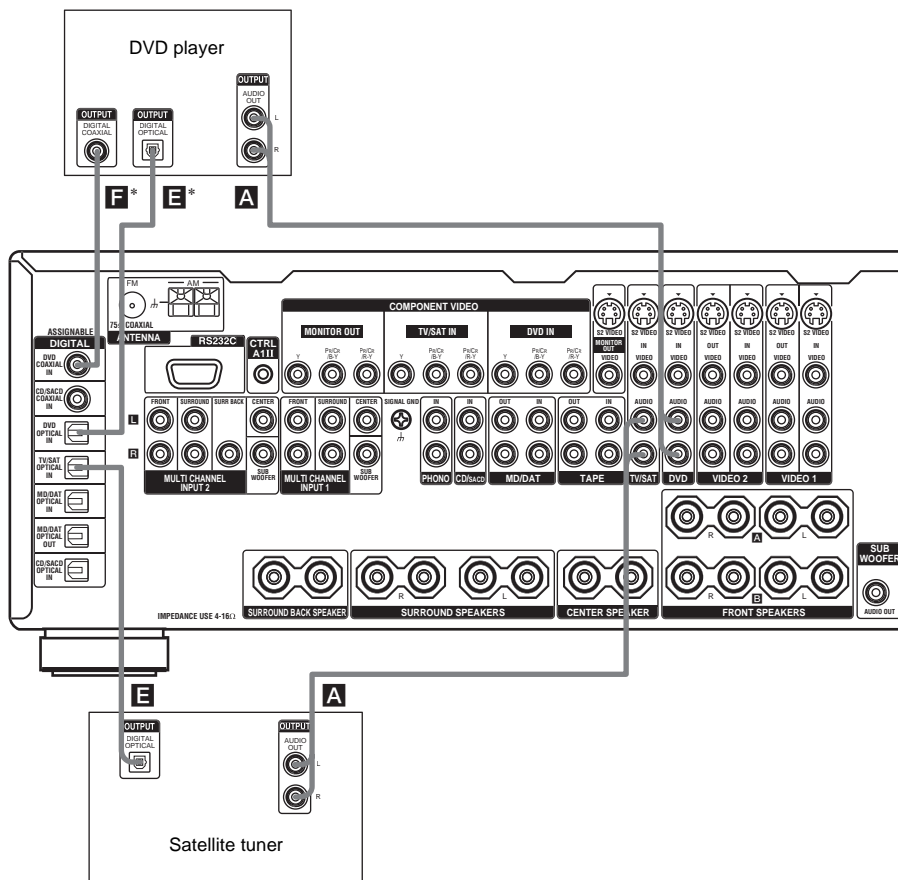

* Connect to either the DVD COAXIAL IN or the DVD OPTICAL IN jack. We recommend making connections to the DVD COAXIAL IN jack.

Note

You can listen to the sound of your TV by connecting your TV's audio output jacks to the TV/SAT AUDIO IN jacks on the receiver. In this case, do not connect the TV's video output jack to the TV/SAT VIDEO IN jack on the receiver.

2 Connect the video jacks.

The following illustration shows how to connect a TV or satellite tuner and a DVD player with COMPONENT VIDEO (Y, P_B/C_B/B-Y, P_R/C_R/R-Y) output jacks. Connecting a TV with component video input jacks allows you to enjoy higher quality video. You can upconvert the video signals, and adjust the hue, etc. of the converted signals (page 43).

Notes

- On this receiver, standard video signals can be converted to component video or S-video signals, and S-video signals can be converted to component video signals. However, you cannot convert the component video signals to standard video or S-video signals.
- When standard video signals (composite video signals) or S-video signals from a VCR etc. are converted upward on this receiver and then output to your TV, depending on the status of the video signal output, the image on the TV screen may appear distorted horizontally or no image may be output.

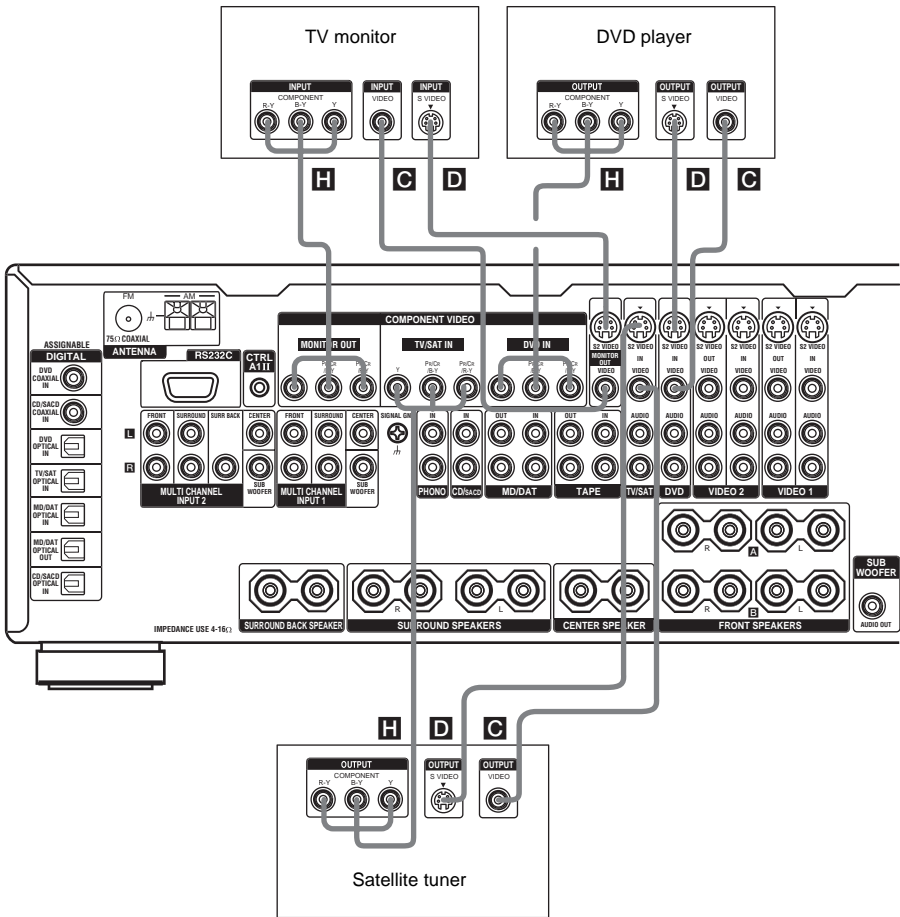

Hooking up a CD/Super Audio CD player or MD/DAT deck

For details on the required cords (A–H), see page 7.

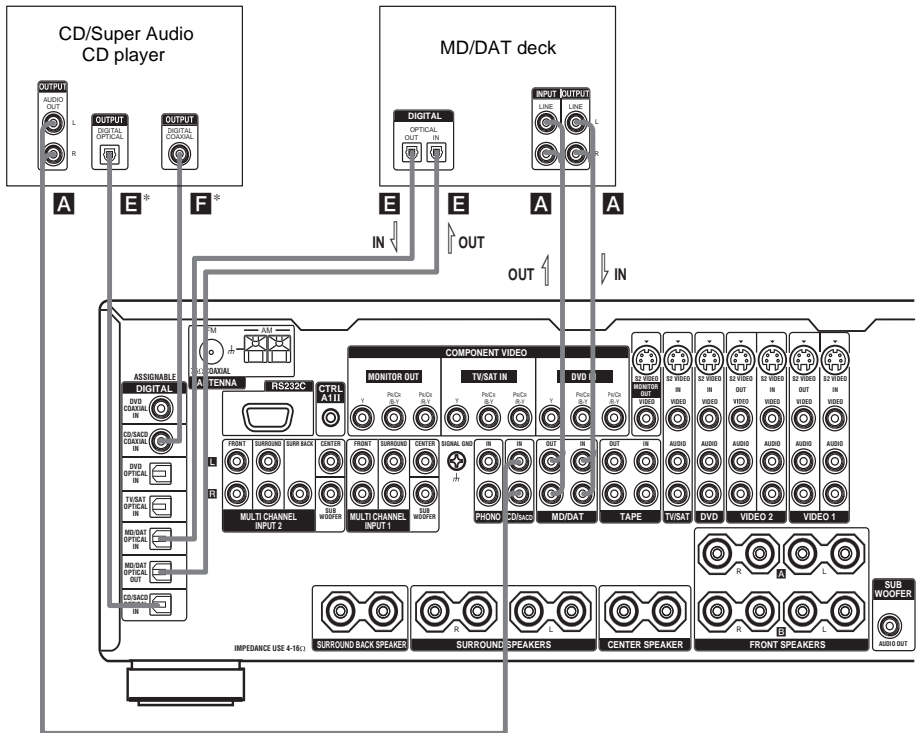

* Connect to either the CD/SACD COAXIAL IN or the CD/SACD OPTICAL IN jack. We recommend making connections to the CD/SACD COAXIAL IN jack.

If you want to connect several digital components, but cannot find an unused input

See “Assigning the audio input” (page 38).

Tips

- All the digital audio jacks are compatible with 32 kHz, 44.1 kHz, 48 kHz and 96 kHz sampling frequencies.
- You can also connect an LD player with a DOLBY DIGITAL RF OUT jack via an RF demodulator (You cannot connect an LD player’s DOLBY DIGITAL RF OUT jack directly to this unit’s digital input jacks). Refer to the operating instructions supplied with the RF demodulator.

Notes

- No sound is output when playing a Super Audio CD disc on a Super Audio CD player connected to the CD/SACD OPTICAL or COAXIAL IN jack on this receiver. Connect the player to the analog input jacks (CD/SACD IN jacks). Refer to the operating instructions supplied with the Super Audio CD player.
- You cannot make digital recordings of digital multi channel surround signals.

1b: Connecting components with multi channel output jacks

1 Connect the audio jacks.

If your DVD or Super Audio CD player is equipped with multi channel output jacks, you can connect it to this receiver's MULTI CHANNEL INPUT jacks to enjoy the multi channel sound. Alternatively, the multi channel input jacks can be used to connect an external multi channel decoder. For details on the required cords (A-H), see page 7.

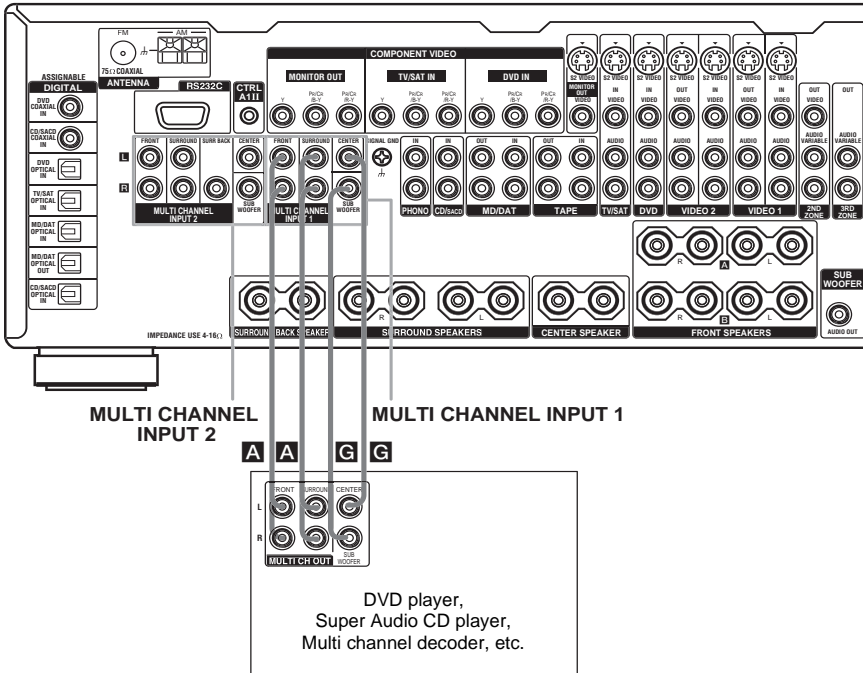

Tips

- This connection also allows you to enjoy software with multi-channel audio recorded in formats other than the Dolby Digital and DTS.
- Make connections to either the MULTI CHANNEL INPUT 1 or MULTI CHANNEL INPUT 2 jacks according to the number of audio output jacks of the component.

Note

DVD and Super Audio CD players do not have SURR BACK terminals.

2 Connect the video jacks.

The following illustration shows how to connect a DVD player with COMPONENT VIDEO (Y, P_B/C_B/B-Y, P_R/C_R/R-Y) output jacks. Connecting a TV with component video input jacks allows you to enjoy higher quality video. You can upconvert the video signals, and adjust the hue, etc. of the converted signals (page 43).

Notes

- On this receiver, standard video signals can be converted to component video or S-video signals, and S-video signals can be converted to component video signals. However, you cannot convert the component video signals to standard video or S-video signals.
- When standard video signals (composite video signals) or S-video signals from a VCR etc. are converted upward on this receiver and then output to your TV, depending on the status of the video signal output, the image on the TV screen may appear distorted horizontally or no image may be output.

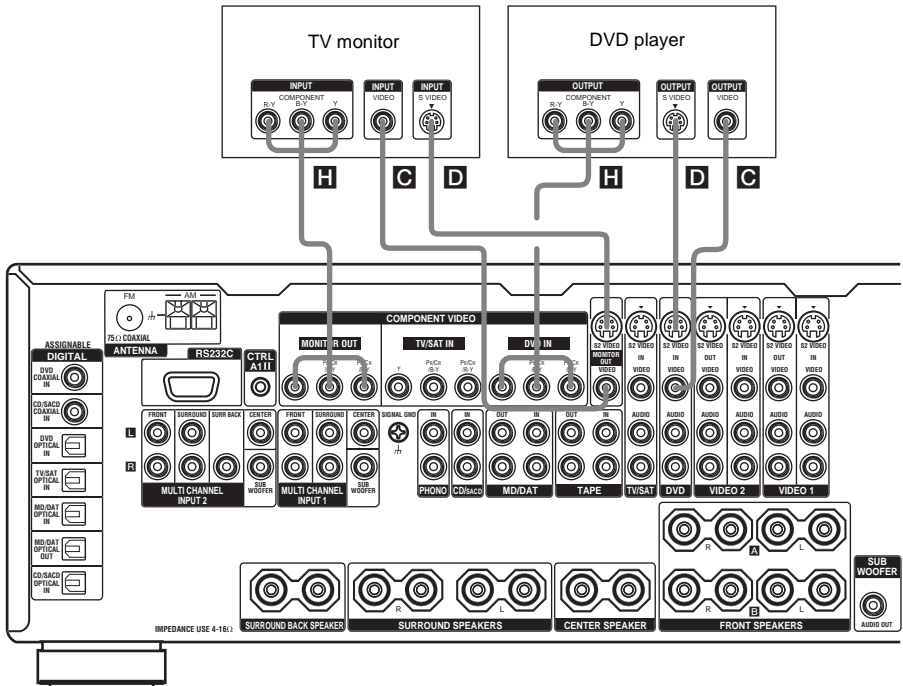

1c: Connecting components with only analog audio jacks

Hooking up audio components

For details on the required cords (A–H), see page 7.

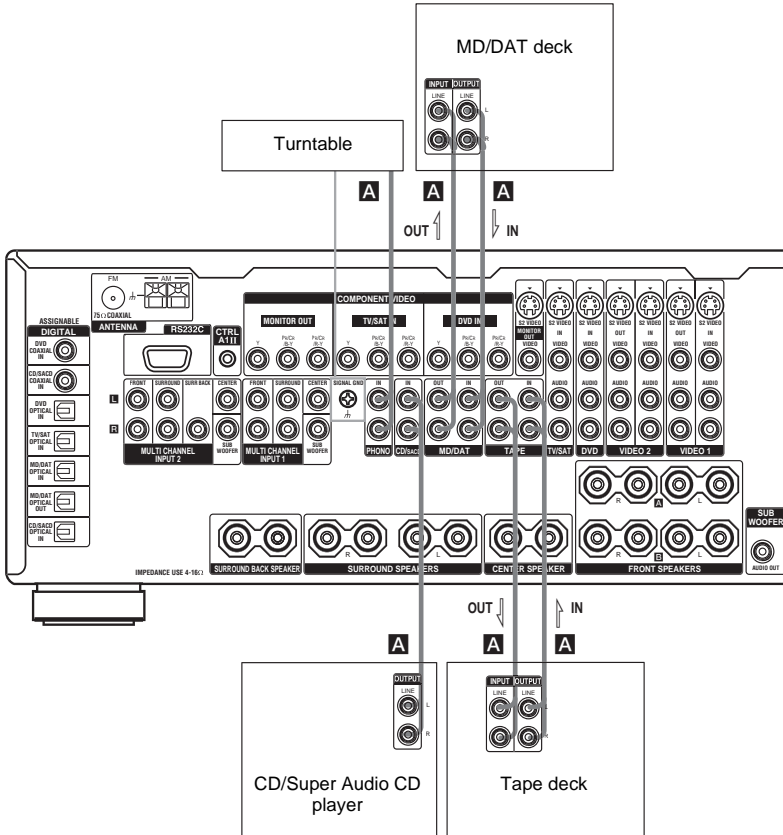

Note

If your turntable has a ground wire, connect it to the h SIGNAL GND terminal.

Hooking up video components

If you connect your TV to the MONITOR jacks, you can watch the video from the selected input (page 24). You can also display the SPEAKER SET UP, LEVEL, SURR SET UP, EQUALIZER, CUSTOMIZE and TUNER menu settings and sound fields on your TV by pressing ON SCREEN on the remote.

For details on the required cords (**A-H**), see page 7.

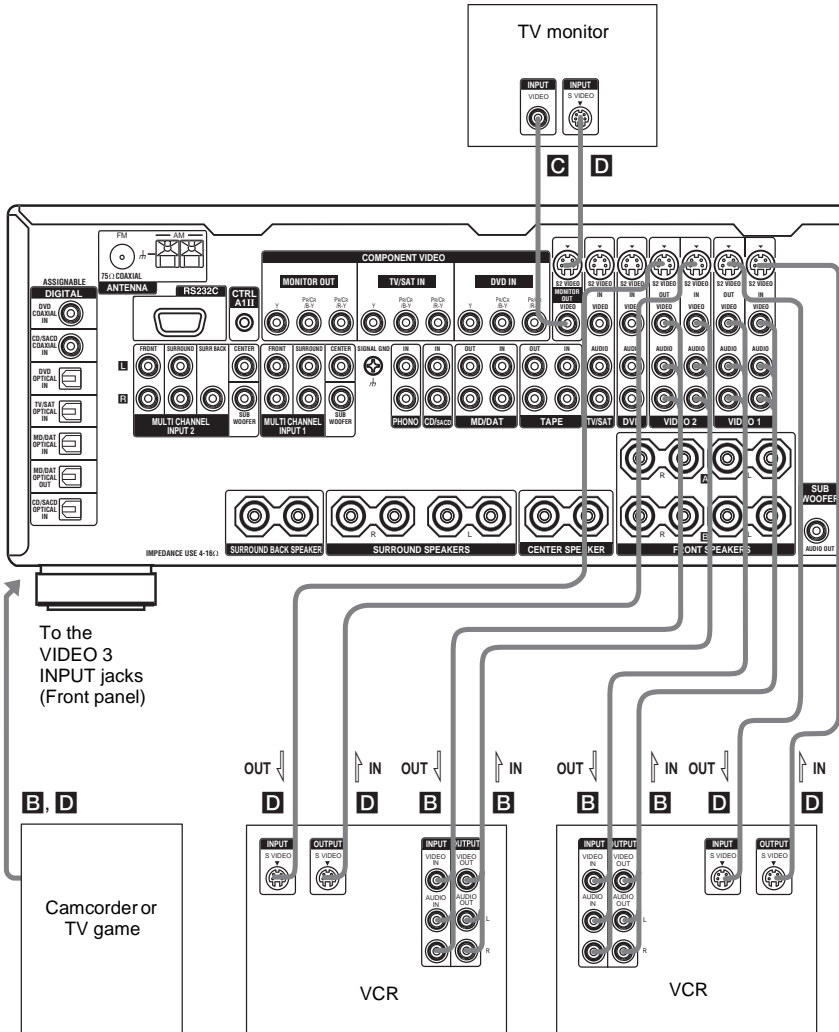

2: Connecting the antennas

Connect the supplied AM loop antenna and FM wire antenna.

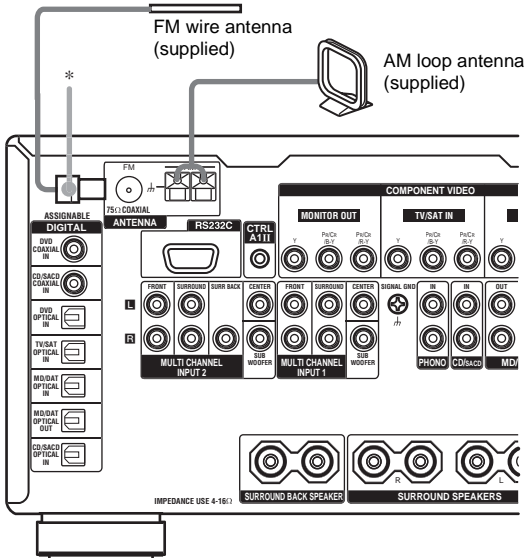

* The shape of the connector varies depending on the area code.

Notes

- To prevent noise pickup, keep the AM loop antenna away from the receiver and other components.
- Be sure to fully extend the FM wire antenna.
- After connecting the FM wire antenna, keep it as horizontal as possible.
- Do not use the ⏏ SIGNAL GND terminal for grounding the receiver.

3: Connecting speakers

Connect your speakers to the receiver. This receiver allows you to use a 7.1 channel system (except for STR-DA3000ES models of area code CEL, TW) or 6.1 channel (STR-DA3000ES models of area code CEL, TW only).

To fully enjoy theater-like multi channel surround sound requires five speakers (two front speakers, a center speaker, and two surround speakers) and a sub woofer (5.1 channel).

You can enjoy high fidelity reproduction of DVD software recorded in the Surround EX format if you connect one additional surround back speaker (6.1 channel) or two surround back speakers (7.1 channel). Except for STR-DA3000ES models of area code CEL, TW) (see “Selecting the surround back decoding mode” on page 36).

Example of 7.1 channel speaker system configuration

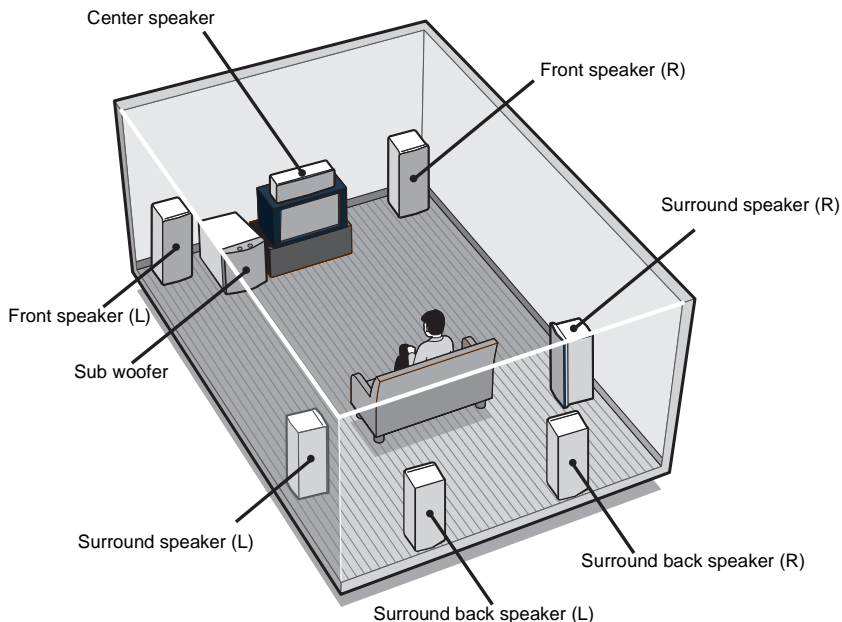

Tips

- When you connect 6.1 channel speaker system, place the surround back speaker behind the listening position.
- Since the sub woofer does not emit highly directional signals, you can place it wherever you want.

Required cords

A Speaker cords (not supplied)



B Monaural audio cord (not supplied)

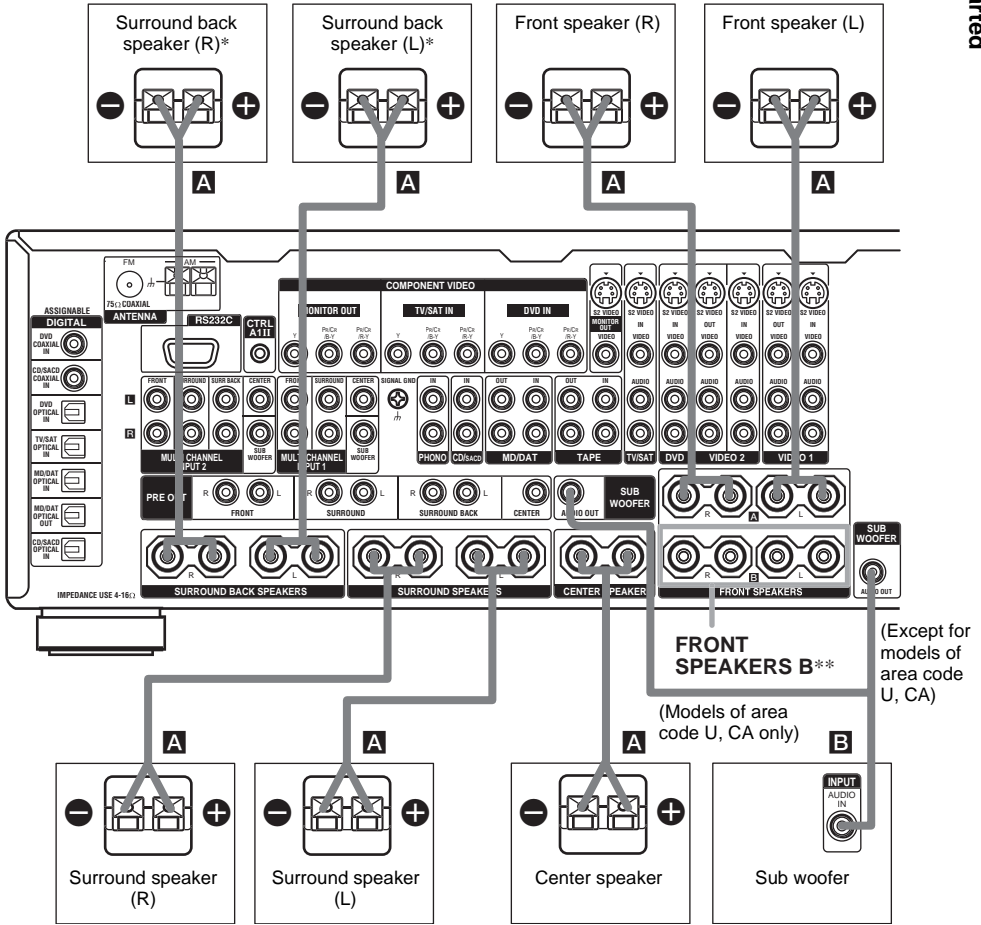

* If you connect only one surround back speaker, connect it to the SURROUND BACK SPEAKERS L terminal (except for STR-DA3000ES models of area code CEL, TW).

STR-DA3000ES models of area code CEL, TW have only one SURROUND BACK SPEAKER terminal.

**You can select the front speakers you want to use with SPEAKERS. For details, see "Selecting the speaker system" (page 50).

Tip (Models of area code U, CA only)

To connect certain speakers to another power amplifier, use the PRE OUT jacks. The same signal is output from both the SPEAKERS jacks and the PRE OUT jacks. For example, if you want to connect just the front speakers to another amplifier, connect that amplifier to the PRE OUT FRONT L and R jacks.

4: Connecting the AC power cord

Connect the supplied AC power cord to the AC IN terminal on the receiver, then connect the AC power cord to a wall outlet.

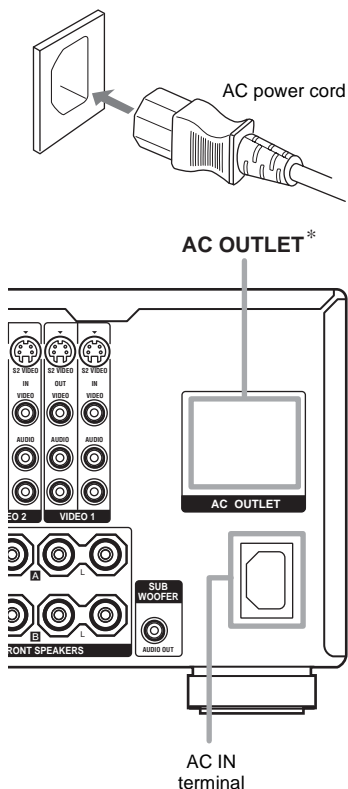

* The configuration, shape, and number of AC outlets vary according to the area code.

Notes

- The AC OUTLET(s) on the rear of the receiver is a switched outlet, which supplies power to the connected component only while the receiver is turned on.
- Make sure that the total power consumption of the component(s) connected to the receiver's AC OUTLET(s) does not exceed the wattage stated on the rear panel. Do not connect high-wattage electrical home appliances such as electric irons,

fans, or TVs to this outlet. This may cause a malfunction.

Before using the receiver

Performing initial setup operations

Before using the receiver for the first time, initialize the receiver by performing the following procedure.

This procedure can also be used to return settings you have made to their factory defaults.

- 1 Press I/⏻ on the receiver to turn off the receiver.
- 2 Hold down I/⏻ on the receiver for 5 seconds.
- 3 While "ENTER to Clear All" appears in the display, press MEMORY/ENTER on the receiver.

After "MEMORY CLEARING..." appears in the display for a while, "MEMORY CLEARED!" appears.

The following are reset to their factory settings.

- All settings in the SPEAKER SET UP, LEVEL, SURR SET UP, EQUALIZER, CUSTOMIZE, TUNER and CIS (models of area code U, CA only) menus.
- The sound field memorized for each input and preset station.
- All preset stations.
- All index names for inputs and preset stations.

Note

If "2nd zone on" or "3rd zone on" appears in the display, the initial setup operation cannot be performed. Turn off the indication by following the first tip of "Listening to the sound in another zone" (page 52).

Before using the remote for the first time (STR-DA5000ES only)

When you use the remote for the first time, be sure to perform the following procedure. The remote is optimized for the receiver.

- 1 Press RM SET UP.

- 2 Move the easy scroll key to select “AMP REGIST”, then press the key to enter the selection.
- 3 If the displayed model name is same as the model you use, select “Exit”. If a different model name or “? ? ?” appears, move the easy scroll key to select “START”, then press the key to enter the selection.

After “SEARCHING” appears, the model name appears. Make sure to keep the remote pointing toward the receiver until the model name appears. The remote is reset, turns off, and optimized for the model. The customized settings of the remote is cleared and reset to their factory settings.

5: Setting up the speakers

You can use the SPEAKER SET UP menu to set the size and distance of the speakers connected to this system.

- 1 Press I/⏻ to turn on the system.
- 2 Rotate MAIN MENU to select “SPEAKER SET UP”.
- 3 Rotate MENU to select the menu item you want.

For more information, see “Speaker setup parameters”.

Notes

- Certain setup parameters may be dimmed in the display. This means that the selected parameter is either unavailable or fixed and unchangeable due to sound field (pages 34–36) or other settings.
- Some speaker setup items may appear dimmed in the display. This means that they have been adjusted automatically due to other speaker settings. Depending on the settings, you may or may not be able to adjust certain speakers.

- 4 Rotate -/+ to select the parameter.
- 5 Repeat steps 3 and 4 until you have set all of the items that follow.

Speaker setup parameters

The initial settings are underlined.

■ SP EASY SET UP (Speaker easy setup)

- YES

You can set up your speakers automatically by selecting a pre-defined speaker pattern (see the supplied “Easy Setup Guide”).

- NO

Select to adjust the settings of each speaker manually.

■ SPEAKER PATTERN (Speaker setup pattern)

When “SP EASY SET UP” is set to “YES”, select the speaker setup pattern. Rotate -/+ to select the speaker setup pattern and press MEMORY/ENTER to enter the selection.

Check your speaker pattern using the supplied “Easy Setup Guide”.

■ SUB WOOFER (Sub woofer)

- YES

If you connect a sub woofer, select “YES”.

- NO

If you did not connect a sub woofer, select “NO”. This activates the bass redirection circuitry and outputs the LFE signals from other speakers.

■ FRONT SP (Front speakers)

- LARGE

If you connect large speakers that will effectively reproduce bass frequencies, select “LARGE”. Normally, select “LARGE”.

When the sub woofer is set to “NO”, front speakers are automatically set to “LARGE”.

- SMALL

If the sound is distorted, or you feel a lack of surround effects when using multi channel surround sound, select “SMALL” to activate the bass redirection circuitry and output the front channel bass frequencies from the sub woofer. When the front speakers are set to “SMALL”, the center, surround and surround back speakers are also automatically set to “SMALL” (unless previously set to “NO”).

■ CENTER SP (Center speaker)

- LARGE

If you connect a large speaker that will effectively reproduce bass frequencies, select “LARGE”. Normally, select “LARGE”.

However, if the front speakers are set to “SMALL”, you cannot set the center speaker to “LARGE”.

- SMALL

If the sound is distorted, or you feel a lack of surround effects when using multi channel surround sound, select “SMALL” to activate the bass redirection circuitry and output the center channel bass frequencies from the front speakers (if set to “LARGE”) or sub woofer.

- NO

If you did not connect a center speaker, select “NO”. The sound of the center channel will be output from the front speakers.

When the multi channel input is selected, analog downmixing is performed.

■ SURROUND SP (Surround speakers)

The surround back speakers are set to the same setting.

- LARGE

If you connect large speakers that will effectively reproduce bass frequencies, select “LARGE”. Normally, select “LARGE”. However, if the front speakers are set to “SMALL”, you cannot set the surround speakers to “LARGE”.

- SMALL

If the sound is distorted, or you feel a lack of surround effects when using multi channel surround sound, select “SMALL” to activate the bass redirection circuitry and output the surround channel bass frequencies from the sub woofer or other “LARGE” speakers.

- NO

If you did not connect surround speakers, select “NO”.

■ SURR BACK SP (Surround back speakers)

When the surround speakers are set to “NO”, the surround back speakers are also automatically set to “NO” and the setting cannot be changed.

Except for STR-DA3000ES models of area code CEL, TW

- DUAL

If you connect two surround back speakers, select “DUAL”. The sound will be output to a maximum of 7.1 channels.

- SINGLE

If you connect only one surround back speaker, select “SINGLE”. The sound will be output to a maximum of 6.1 channels.

- NO

If you did not connect surround back speakers, select “NO”.

STR-DA3000ES models of area code CEL, TW only

- YES

If you connect a surround back speaker, select “YES”.

- NO

If you did not connect surround back speaker, select “NO”.

Tip

The “LARGE” and “SMALL” settings for each speaker determine whether or not the internal sound processor will cut the bass signal from that channel. When the bass is cut from a channel, the bass redirection circuitry sends the corresponding bass frequencies to the sub woofer or other “LARGE” speakers.

However, it best not to cut them, if possible. Therefore, even when using small speakers, you can set them to “LARGE” if you want to output the bass frequencies from that speaker. On the other hand, if you are using a large speaker, but prefer not to have bass frequencies output from that speaker, set it to “SMALL”.

If the overall sound level is lower than you prefer, set all speakers to “LARGE”. If there is not enough bass, you can use the equalizer to boost the bass levels. To adjust the equalizer, see page 41.

■ **FRONT XXX meter***
(Front speaker distance)

Initial setting: 3.0 meter (10 feet)

Lets you set the distance from your listening position to the front speakers (A). You can adjust from 1.0 meter to 7.0 meters (3 to 23 feet) in 0.1 meter (1 foot) steps.

If both front speakers are not placed an equal distance from your listening position, set the distance to the closest speaker.

When placing only one surround back speaker

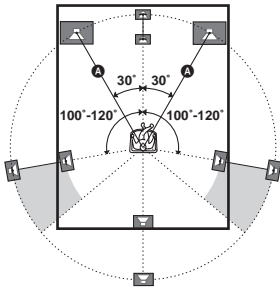

When placing two surround back speakers (The angle B should be the same)

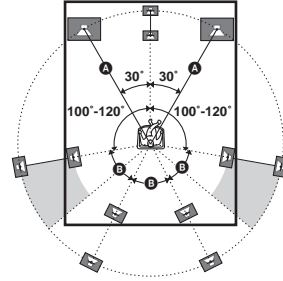

■ **CENTER XXX meter***
(Center speaker distance)

Initial setting: 3.0 meter (10 feet)

Lets you set the distance from your listening position to the center speaker. You can adjust from 1.0 meter to 7.0 meters (3 to 23 feet) in 0.1 meter (1 foot) steps.

■ **SURROUND XXX meter***
(Surround speaker distance)

Initial setting: 3.0 meter (10 feet)

Lets you set the distance from your listening position to the surround speakers. You can adjust from 1.0 meter to 7.0 meters (3 to 23 feet) in 0.1 meter (1 foot) steps.

If both surround speakers are not placed an equal distance from your listening position, set the distance to the closest speaker.

■ **SURR BACK XXX meter***
(Surround back speaker distance)

Initial setting: 3.0 meter (10 feet)

Lets you set the distance from your listening position to the surround back speaker. You can adjust from 1.0 meter to 7.0 meters (3 to 23 feet) in 0.1 meter (1 foot) steps.

If you connect two surround back speakers and both surround back speakers are not placed an equal distance from your listening position (Except for STR-DA3000ES models of area code CEL, TW), set the distance to the closest speaker.

■ **SUB WOOFER XXX meter***
(Sub woofer distance)

Initial setting: 3.0 meter (10 feet)

Lets you set the distance from your listening position to the sub woofer. You can adjust from

1.0 meter to 7.0 meters (3 to 23 feet) in 0.1 meter (1 foot) steps.

* For models of area code U, CA, “X feet” is displayed.

Tip

The receiver lets you to input the speaker position in terms of distance. However, it is not possible to set the center speaker further than the front speakers. Also, the center speaker cannot be set more than 1.5 meters (5 feet) closer than the front speakers.

Likewise, the surround speakers can not be set farther away from the listening position than the front speakers. And they can be no more than 4.5 meters (15 feet) closer.

This is because incorrect speaker placement is not conducive to the enjoyment of surround sound.

Please note that, setting the speaker distance closer than the actual location of the speakers will cause a delay in the output of the sound from that speaker. In other words, the speaker will sound like it is farther away.

For example, setting the center speaker distance 1–2 meters (3–6 feet) closer than the actual speaker position will create a fairly realistic sensation of being “inside” the screen. If you cannot obtain a satisfactory surround effect because the surround speakers are too close, setting the surround speaker distance closer (shorter) than the actual distance will create a larger sound stage.

Adjusting these parameter while listening to the sound often results in much better surround sound. Give it a try!

For advanced speaker setups

Use the CUSTOMIZE menu and set “MENU EXPAND” to “ON”. This enables advanced setups including those of the heights of the surround speakers.

For details on “MENU EXPAND”, see page 42.

For details on how to set the items, see page 44.

6: Adjusting the speaker levels and balance

— TEST TONE

Adjust the speaker levels and balance while listening the test tone from your listening position. Use the remote for the operation. For details on the remote operation, refer to the operating instructions supplied with the remote.

Tip

The receiver employs a test tone with a frequency centered at 800 Hz.

1 Press **I/⏪** on the remote to turn on the receiver.

2 **RM-LJ312:**
Press **<** on the remote repeatedly until **RECEIVER** menu appears.
Move the easy scroll key to select “**TEST TONE**”, then press the key to enter the selection.

RM-LG112:
Press **TEST TONE** on the remote.

“**TEST TONE**” in the **LEVEL** menu appears in the display and the test tone is output from each speaker in sequence.

3 **Adjust the speaker level and balance using the LEVEL menu so that the level of the test tone sounds the same from each speaker.**

For details on the **LEVEL** menu settings, see page 40.

Tips

- To adjust the level of all speakers at the same time, press **MASTER VOL +/-** on the remote or turn **MASTER VOLUME** on the receiver.
- You can also use **-/+** on the receiver for the adjustment.

4 **RM-LJ312:**
After the adjustment, press **<** on the remote repeatedly again until **RECEIVER** menu appears.
Move the easy scroll key to select “**TEST TONE**”, then press the key repeatedly to select “**TEST TONE [OFF]**”.

RM-LG112:

Press TEST TONE again.

The test tone turns off.

To output the test tone only from a specific speaker

Set “TEST TONE” in the LEVEL menu to “FIX” (page 40). The test tone is output only from the selected speaker.

For more precise adjustment

You can output the test tone or sound source from two adjacent speakers to adjust their balance and level.

Set “MENU EXPAND” in the CUSTOMIZE menu to “ON” (page 42). Then select the two speakers you want to adjust using “PHASE NOISE” or “PHASE AUDIO” in the LEVEL menu (page 46).

Amplifier Operation

Selecting the component

1 Rotate INPUT SELECTOR to select the input.

The selected input appears in the display.

To select the	Display
VCR	VIDEO 1 or VIDEO 2
Camcorder or TV game	VIDEO 3
DVD player	DVD
Satellite tuner	TV/SAT
Tape deck	TAPE
MD or DAT deck	MD/DAT
CD or Super Audio CD player	CD/SACD
Built-in tuner	FM or AM and frequency
Turntable	PHONO

2 Turn on the component and start playback.

3 Rotate MASTER VOLUME to adjust the volume.

To mute the sound

Press MUTING on the remote. To cancel, press MUTING on the remote again or turn MASTER VOLUME clockwise to raise the volume. Even if you turn off the receiver, the muting function works when you turn on the receiver again.

Notes on using headphones

- When headphones are connected, you can select only the following sound fields (page 35).
 - HEADPHONE (2CH)
 - HEADPHONE (DIRECT)
 - HEADPHONE (MULTI 1)
 - HEADPHONE (MULTI 2)
 - HEADPHONE THEATER
- When headphones are connected and you use the MULTI CH IN function (page 25), the sound of all channels may not output depending on the speaker settings.

Listening to multi channel sound

— MULTI CH IN

You can select the audio directly from the components connected to the MULTI CHANNEL INPUT jacks. This enables you to enjoy high quality analog inputs like DVD or Super Audio CD.

Surround effects are not activated when using this input.

Press MULTI CH IN 1/2 repeatedly to select the multi channel audio source (“MULTI CH 1 DIRECT” or “MULTI CH 2 DIRECT”).

The selected audio source is output.

When a center speaker or sub woofer is not connected

If you have set the center speaker to “NO”, or set the sub woofer to “NO” in the SPEAKER SET UP menu (page 19), and you activate the MULTI CH IN function, the analog center or sub woofer audio will be output from the front left and right speakers.

Listening to FM/AM radio

You can listen to FM and AM broadcasts through the built-in tuner. Before operation, make sure you have connected the FM and AM antennas to the receiver (see page 15).

Tip

The tuning scale for direct tuning differs depending on the area code as shown in the following table. For details on area codes, see page 3.

Area code	FM	AM
U, CA	100 kHz	10 kHz*
CEL, TW	50 kHz	9 kHz

* The AM tuning scale can be changed (see page 61).

Automatic tuning

- 1 Rotate INPUT SELECTOR to select tuner (“FM” or “AM”).
- 2 Press FM/AM to select “FM” or “AM”.
- 3 Press TUNING + or TUNING –.
 - Press TUNING + to scan from low to high; press TUNING – to scan from high to low. The receiver stops scanning whenever a station is received.

In case of poor FM stereo reception

If the FM stereo reception is poor and “STEREO” flashes in the display, select monaural audio so that the sound will be less distorted.

- 1 Rotate MAIN MENU to select “TUNER”.
- 2 Rotate MENU to select “FM MODE”.
- 3 Rotate –/+ to select “MONO”.

The FM reception switches to monaural.

Direct tuning

Enter a frequency of the station directly by using NUM menu or numeric buttons on the remote. For details on the supplied remote, refer to the operating instructions supplied with the remote.

RM-LJ312

- 1 Press INPUT SELECTOR, then select “TUNER” from the input list.**
You can also use INPUT SELECTOR on the receiver.
- 2 Press > repeatedly until SUB menu appears, then select “FM/AM” from the SUB menu to select the FM or AM band.**
You can also use FM/AM on the receiver.
- 3 Select “DIRECT TUNING” from the SUB menu.**
- 4 Press > on the remote repeatedly until NUM menu appears, then select the numbers for the frequency.**

Example 1: FM 102.50 MHz

Select 1 ➔ 0 ➔ 2 ➔ 5 ➔ 0

(You do not have to enter the last “0” when the tuning scale is set to 100 kHz.)

Example 2: AM 1,350 kHz

Select 1 ➔ 3 ➔ 5 ➔ 0

(You do not have to enter the last “0” when the tuning scale is set to 10 kHz.)

If you have tuned in an AM station, adjust the direction of the AM loop antenna for optimum reception.

RM-LG112

- 1 Move the easy scroll key to select “TUNER”, then press the key repeatedly to select “FM” or “AM”.**
You can also use INPUT SELECTOR on the receiver.
- 2 Press ALT, then press D.TUNING on the remote.**
- 3 Press the numeric buttons to enter the frequency.**

Example 1: FM 102.50 MHz

Select 1 ➔ 0 ➔ 2 ➔ 5 ➔ 0

(You do not have to enter the last “0” when the tuning scale is set to 100 kHz.)

Example 2: AM 1,350 kHz

Select 1 ➔ 3 ➔ 5 ➔ 0

(You do not have to enter the last “0” when the tuning scale is set to 10 kHz.)

If you have tuned in an AM station, adjust the direction of the AM loop antenna for optimum reception.

If you cannot tune in a station and the entered numbers flash

Make sure you have entered the right frequency. If not, repeat step 4 (RM-LJ312) or step 3 (RM-LG112). If the entered numbers still flash, the frequency is not used in your area.

Storing FM stations automatically

— AUTOBETICAL

(Models of area code CEL only)

This function lets you store up to 30 FM and FM RDS stations in alphabetical order without redundancy. Additionally, it only stores the stations with the clearest signals.

If you want to store FM or AM stations one by one, see “Presetting radio stations”.

- 1 Press I/⏻ to turn off the receiver.**
- 2 Hold down MEMORY/ENTER and press I/⏻ to turn the receiver back on.**

“Autobetical select” appears in the display and the receiver scans and stores all the FM and FM RDS stations in the broadcast area. For RDS stations, the tuner first checks for stations broadcasting the same program, then stores only the one with the clearest signal. The selected RDS stations are sorted alphabetically by their Program Service name, then assigned a 2-character preset code. For more details on RDS, see page 28.

Regular FM stations are assigned 2-character preset codes and stored after the RDS station.

When done, “Autobetical finished” appears in the display momentarily and the receiver returns to the normal operation.

Notes

- Do not press any button on the receiver or supplied remote during autobetical operation, except I/⏻.
- If you move to another area, repeat this procedure to store stations in your new area.
- For details on tuning the stored stations, see “Tuning to preset stations”.
- If you move the antenna after storing stations with this procedure, the stored settings may no longer be valid. If this happens, repeat this procedure to store the stations again.

Presetting radio stations

You can preset up to 30 FM or AM stations. Then you can easily tune in the stations you often listen to.

Presetting radio stations

- 1 Rotate INPUT SELECTOR to select tuner (“FM” or “AM”).**
- 2 Press FM/AM to select “FM” or “AM”.**
- 3 Tune in the station that you want to preset using Automatic Tuning (page 25) or Direct Tuning (page 26).**
Switch the FM reception mode if necessary (page 25).
- 4 Press MEMORY/ENTER.**
“MEMORY” appears in the display for a few seconds. Do steps 5 to 6 before the display goes out.
- 5 Press PRESET TUNING + or PRESET TUNING – to select a preset number.**
If you want to switch the memory page, press SHIFT on the remote.
If “MEMORY” goes out before you select the preset number, start again from step 4.
- 6 Press MEMORY/ENTER again.**
The station is stored to the selected preset number.
If “MEMORY” goes out before you press MEMORY/ENTER, start again from step 4.
- 7 Repeat steps 2 to 6 to preset another station.**

Tuning to preset stations

- 1 Rotate INPUT SELECTOR to select tuner (“FM” or “AM”).**
- 2 Press PRESET TUNING + or PRESET TUNING – repeatedly to select the preset station you want.**

Each time you press the button, you can select the preset station as follows:

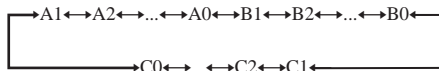

Using the remote

RM-LJ312

- 1 Press INPUT SELECTOR, then move the easy scroll key to select "TUNER" from the input list.
- 2 Move the easy scroll key to select the preset number you want, then press the key to enter the selection.

RM-LG112

- 1 Move the easy scroll key to select "TUNER", then press the key repeatedly to select "FM" or "AM".
- 2 Press D.SKIP/CH/PRESET +/- repeatedly to select the preset station you want.

Using the Radio Data System (RDS)

(Models of area code CEL only)

This receiver also allows you to use RDS (Radio Data System), which enables radio stations to send additional information along with the regular program signal. You can display RDS information.

Receiving RDS broadcasts

Simply select a station on the FM band using direct tuning (page 26), automatic tuning (page 25), or preset tuning (page 27).

When you tune in a station that provides RDS services, the RDS indicator lights up and the program service name appears in the display.

Note

RDS may not work properly if the station you tuned to is not transmitting the RDS signal properly or if the signal strength is weak.

Displaying RDS information

While receiving an RDS station, press DISPLAY.

Each time you press the button, RDS information on the display changes cyclically as follows:

Top level

One of the followings, band, and preset number is displayed:

- PS (Program Service name)^{a)}
- Present station name^{b)}
- Frequency

Lower level

PTY (Program Type) indication^{c)} → RT (Radio Text) indication^{d)} → CT (Time) indication (in 24-hour system level) → Sound field currently applied

- ^{a)} This information also appears for non-RDS FM stations.
- ^{b)} Appears only when the preset station is indereed.
- ^{c)} Type of program being broadcast (see page 29).
- ^{d)} Text messages sent by the RDS station.

Notes

- If there is an emergency announcement by government authorities, “Alarm-Alarm!” flashes in the display.
- If a station does not provide a particular RDS service, “No XX” (such as “No Clock Time”) appears in the display.
- When a station broadcasts radio text data, it is displayed at the same rate at which it is sent from the station. Any change in this rate is reflected in the display rate of the data.

Description of program types

Program type indication	Description
News	News programs
Current Affairs	Topical programs that expand on current news
Information	Programs offering information on a wide spectrum of subjects, including consumer affairs and medical advice
Sport	Sports programs
Education	Educational programs, such as “how-to” and advice programs
Drama	Radio plays and serials
Cultures	Programs about national or regional culture, such as language and social concerns
Science	Programs about the natural sciences and technology
Varied Speech	Other types of programs such as celebrity interviews, panel games, and comedy
Pop Music	Popular music programs
Rock Music	Rock music programs
M.o.R. Music	Easy Listening
Light Classics M	Instrumental, vocal, and choral music
Serious Classics	Performances of major orchestras, chamber music, opera, etc.
Other Music	Music that does not fit into any categories above, such as Rhythm & Blues and Reggae
Wether & Metr	Weather information
Finance	Stock market reports and trading, etc.
Children’s Progs	Programs for children

Program type indication	Description
Social Affairs	Programs about people and the things that affect them
Religion	Programs of religious content
Phone In	Programs where members of the public express their views by phone or in a public forum
Travel & Touring	Programs about travel. Not for announcements that are located by TP/TA.
Leisure & Hobby	Programs on recreational activities such as gardening, fishing, cooking, etc.
Jazz Music	Jazz programs
Country Music	Country music programs
National Music	Programs featuring the popular music of the country or region
Oldies Music	Programs featuring oldies music
Folk Music	Folk music programs
Documentary	Investigative features
None	Any programs not defined above

Changing the display

Changing the information in the display

You can check the sound field etc. by changing the information in the display.

Press DISPLAY repeatedly.

Each time you press DISPLAY, the display will change as follows.

All inputs except “FM” and “AM”

Index name and sound field name* ↔ Input name and sound field name

FM and AM

Preset station name and sound field name* ↔ Input name and sound field name

* Index name appears only when you have assigned one to the input or preset station (page 49). Index name does not appear when only blank spaces have been entered, or it is the same as the input name.

Displaying the input stream information

You can check the input stream information (about format, channel, etc.) of digital input signals. The input stream information also appears for 4 seconds when the receiver detects any changes in the digital input signal.

- 1 Rotate MAIN MENU to select “STREAM INFO”.**
- 2 Rotate MENU.**
The input stream information appears.
- 3 Rotate -/+ for more information.**

About the indications in the display

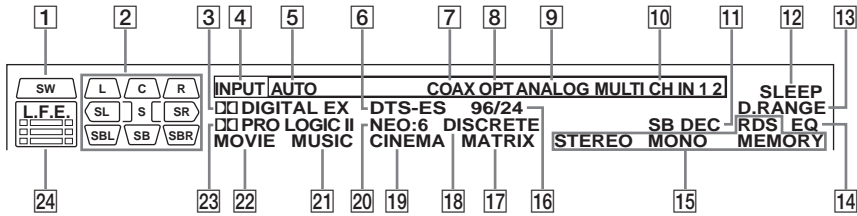

- 1 **SW:** Lights up when sub woofer selection is set to “YES” (page 20). While this indicator lights up, the receiver creates a sub woofer signal based on the LFE signal in the disc being played back or the low frequency components of the front channels. This indicator does not light during the 2CH STEREO mode.
- 2 **Playback channel indicators:** The letters (L, C, R, etc.) indicate the channels being played back. The boxes around the letters vary to show how the receiver downmixes the source sound (based on the speakers settings). L (Front Left), R (Front Right), C (Center (monaural)), SL (Surround Left), SR (Surround Right), S (Surround (monaural) or the surround components obtained by Pro Logic processing), SBL (Surround back Left), SBR (Surround back right), SB (Surround Back (the surround back components obtained by 6.1 channel decoding))

Example:
 Recording format (Front/Surround): 3/2
 Output channel: Surround speakers absent
 Sound Field: A.F.D. AUTO
 A.F.D. 2CH SW in the SURR SET UP menu:
 CREATE
 (The initial setting is “OFF”)

SW	L	C	R
	SL		SR
- 3 **DIGITAL (EX):** Lights up when Dolby Digital signals are input. “EX” lights up when Dolby Digital EX signals are input. When playing a Dolby Digital format disc, be sure that you have made digital connections and that INPUT MODE is NOT set to “ANALOG 2CH FIXED” (page 39).
- 4 **INPUT:** Lights up constantly. One of the input indicators also lights up according to the current input.
- 5 **AUTO:** Lights up when INPUT MODE is set to “AUTO 2CH” (page 39).
- 6 **DTS (-ES):** Lights up when DTS signals are input. “-ES” lights up when DTS-ES signals are input. When playing a DTS format disc, be sure that you have made digital connections and that INPUT MODE is NOT set to “ANALOG 2CH FIXED” (page 39).
- 7 **COAX:** Lights up when the source signal is a digital signal being input through the COAXIAL terminal or when INPUT MODE is set to “COAXIAL FIXED” (page 39).
- 8 **OPT:** Lights up when the source signal is a digital signal being input through the OPTICAL terminal, or when INPUT MODE is set to “OPTICAL FIXED” (page 39).
- 9 **ANALOG:** Lights up when no digital signal is input to COAXIAL or OPTICAL jack, or when INPUT MODE is set to “ANALOG 2CH FIXED” (page 39).
- 10 **MULTI CH IN 1/2:** Lights up when “MULTI CH 1 DIRECT” or “MULTI CH 2 DIRECT” is selected.
- 11 **SB DEC:** Lights up when surround back decoding is activated (page 36).
- 12 **SLEEP:** Lights up when sleep timer is activated.
- 13 **D.RANGE:** Lights up when dynamic range compression is activated (page 46).
- 14 **EQ:** Lights up when the equalizer is activated.

continued

- 15 Tuner indicators:** Lights up when using the receiver to tune in radio stations, etc. See pages 25–29 for tuner operations.
- 16 96/24:** Lights up when the receiver is decoding DTS 96 kHz/24 bit signals.
- 17 MATRIX:** Lights up when DTS-ES Matrix decoding is activated.
- 18 DISCRETE:** Lights up when DTS-ES Discrete decoding is activated.
- 19 CINEMA:** Lights up when DTS Neo:6 Cinema decoding is activated.
- 20 NEO:6:** Lights up when DTS Neo:6 Cinema/Music decoding is activated.
- 21 MUSIC:** Lights up when Pro Logic **II** Music or DTS Neo:6 Music decoding is activated.
- 22 MOVIE:** Lights up when Pro Logic **II** Movie decoding is activated.
- 23  PRO LOGIC (II):** Lights up when the receiver applies Pro Logic processing to 2 channel signals in order to output the center and surround channel signals. This indicator also lights when the Pro Logic **II** Movie/Music decoder is activated. However, this indicator does not light if both the center and surround speakers are set to “NO”.
- 24 L.F.E.:** Lights up when the disc being played back contains the LFE (Low Frequency Effect) channel. When the sound of the LFE channel signal is actually being reproduced, the bars underneath the letters lights up to indicate the level. Since the LFE signal is not recorded in all parts of the input signal the bar indication will fluctuate (and may turn off) during playback.

Enjoying Surround Sound

Using only the front speakers

In this mode, the receiver outputs the sound from the front L/R speakers only. There is no sound from the sub woofer.

Listening to 2 channel stereo sources (2CH STEREO)

Standard 2 channel stereo sources completely bypass the sound field processing and multi channel surround formats are downmixed to 2 channel.

Press 2CH.

“2CH STEREO” appears in the display and the receiver switches to the 2CH STEREO mode.

Note

No sound is output from the sub woofer in the 2CH STEREO mode. To listen to the 2 channel stereo sources using the front L/R speakers and a sub woofer, select “A.F.D. AUTO” and set “A.F.D. 2CH SW” in the SURR SET UP menu to “CREATE”.

Enjoying higher fidelity sound

— AUTO FORMAT DIRECT

The Auto Format Direct (A.F.D.) mode allows you to select the decoding mode you want for your audio sound.

A.F.D. mode	Decoding mode
AUTO	As encoded
PRO LOGIC	Dolby Pro Logic
PRO LOGIC II MOVIE	Dolby Pro Logic II
PRO LOGIC II MUSIC	
Neo:6 Cinema	DTS Neo:6
Neo:6 Music	
MULTI STEREO	

Decoding the input audio signal automatically

In this mode, the receiver automatically detects the type of audio signal being input (Dolby Digital, DTS, standard 2 channel stereo, etc.) and performs the proper decoding if necessary. This mode presents the sound as it was recorded/encoded, without adding any surround effects. However, when “A.F.D. 2CH SW” in the SURR SET UP menu is set to “CREATE” and if there are no low frequency signals (Dolby Digital LFE, etc.) it will generate a low frequency signal for output to the sub woofer.

Press A.F.D. repeatedly to select “A.F.D. AUTO”.

The receiver automatically detects the type of audio signal being input and performs the proper decoding if necessary.

Tip

In most cases, “A.F.D. AUTO” provides the most appropriate decoding. You may want to use SURR BACK DECODING (page 36) to match the input stream to the mode you prefer.

Enjoying stereo sound in multi channel (2 channel decoding mode)

This mode lets you specify the type of decoding for 2 channel audio sources. This receiver can reproduce 2 channel sound in 5 channels through Dolby Pro Logic II; 6 channels through DTS Neo:6; or 4 channels through Dolby Pro Logic. However, DTS 2CH sources are not decoded by DTS Neo:6; they are output in 2 channels.

Press A.F.D. repeatedly to select the 2 channel decoding mode.

■ PRO LOGIC

Performs Dolby Pro Logic decoding. The source recorded in 2 channel is decoded into 4.1 channels.

■ PRO LOGIC II MOVIE

Performs Dolby Pro Logic II Movie mode decoding. This setting is ideal for movies encoded in Dolby Surround. In Addition, this mode can reproduce sound in 5.1 channel when watching videos of overdubbed or old movies.

■ PRO LOGIC II MUSIC

Performs the Dolby Pro Logic II Music mode decoding. This setting is ideal for normal stereo sources such as CDs.

■ Neo:6 Cinema

Performs the DTS Neo:6 Cinema mode decoding.

■ Neo:6 Music

Performs the DTS Neo:6 Music mode decoding. This setting is ideal for normal stereo sources such as CDs.

■ MULTI STEREO

Outputs the 2 channel L/R signals from all speakers.

If you connect a sub woofer

When the source signal does not include a LFE signal, the receiver generates a low frequency signal for output to the sub woofer. However the low frequency signal is not generated for “Neo:6 Cinema” or “Neo:6 Music” when all speakers are set to “LARGE”.

Selecting a sound field

You can take advantage of surround sound simply by selecting one of the receiver’s pre-programmed sound fields. They bring the exciting and powerful sound of movie theaters and concert halls into your home.

Selecting a sound field for movies

Press MOVIE repeatedly to select the sound field you want.

The selected sound field appears in the display.

Sound field

CINEMA STUDIO EX A **DCS**

CINEMA STUDIO EX B **DCS**

CINEMA STUDIO EX C **DCS**

V.MULTI DIMENSION **DCS**

About DCS (Digital Cinema Sound)

Sound fields with **DCS** marks use DCS technology.

DCS is the concept name of the surround technology for home theater developed by Sony. DCS uses the DSP (Digital Signal Processor) technology to reproduce the sound characteristics of an actual cinema cutting studio in Hollywood.

When played at home, DCS will create a powerful theater effect that mimics the artistic combination of sound and action as envisioned by the movie director.

■ CINEMA STUDIO EX A **DCS**

Reproduces the sound characteristics of the Sony Pictures Entertainment “Cary Grant Theater” cinema production studio. This is a standard mode, great for watching most any type of movies.

■ CINEMA STUDIO EX B **DCS**

Reproduces the sound characteristics of the Sony Pictures Entertainment “Kim Novak Theater” cinema production studio. This mode is ideal for watching science-fiction or action movies with lots of sound effects.

■ CINEMA STUDIO EX C DCS

Reproduces the sound characteristics of the Sony Pictures Entertainment scoring stage. This mode is ideal for watching musicals or films where orchestra music is featured in the soundtrack.

■ V.MULTI DIMENSION DCS

Creates 5 sets of virtual speakers from a single pair of actual surround speakers.

About CINEMA STUDIO EX modes

CINEMA STUDIO EX modes are suitable for watching motion picture DVDs (etc.), with multi channel surround effects. You can reproduce the sound characteristics of Sony Pictures Entertainment’s dubbing studio in your home.



The CINEMA STUDIO EX modes consist of the following three elements.

- Virtual Multi Dimension
Creates 5 sets of virtual speakers from a single pair of actual surround speakers.
- Screen Depth Matching
Creates the sensation that the sound is coming from inside the screen like in theaters.
- Cinema Studio Reverberation
Reproduces the type of reverberation found in theaters.

The CINEMA STUDIO EX modes integrate these three elements simultaneously.

Tip

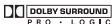
You can identify the encoding format of DVD software, etc. by looking at the logo on the package.

-  : Dolby Digital discs
-  : Dolby Surround encoded programs
-  : DTS Digital Surround encoded programs

Notes

- The effects provided by the virtual speakers may cause increased noise in the playback signal.
- When listening with sound fields that employ the virtual speakers, you will not be able to hear any sound coming directly from the surround speakers.

Selecting a sound field for music

Press **MUSIC** repeatedly to select the sound field you want.

The selected sound field appears in the display.

Sound field

D.CONCERT HALL A

D.CONCERT HALL B

CHURCH

JAZZ CLUB

LIVE CONCERT

STADIUM

SPORTS

■ D.CONCERT HALL A

Uses 3D sound imaging to reproduce the sound characteristics of the CONCERTGEBOUW in Amsterdam, which is famous for a large sound stage produced by reflectivity.

■ D.CONCERT HALL B

Uses 3D sound imaging to reproduce the sound characteristics of the MUSIKVEREIN in Vienna, which is famous for its hall resonance and unique reverberative sound.

■ CHURCH

Reproduces the acoustics of a stone church.

■ JAZZ CLUB

Reproduces the acoustics of a jazz club.

■ LIVE CONCERT

Reproduces the acoustics of a 300-seat live house.

■ STADIUM

Reproduces the feeling of a large open-air stadium.

■ SPORTS

Reproduces the feeling of sports broadcasting.

When the headphones are connected

You can select only from the following sound fields.

■ HEADPHONE (2CH)

Press 2CH or A.F.D. Outputs the sound in 2 channel (stereo). Standard 2 channel stereo sources completely bypass the sound field processing and multi channel surround formats are downmixed to 2 channels.

■ HEADPHONE (DIRECT)

Press DIRECT. Outputs the signals without digital processing by the equalizer, sound field, etc.

■ HEADPHONE (MULTI 1/MULTI 2)

Press MULTI CH 1/2. Outputs the analog signals input to the MULTI CHANNEL INPUT jacks.

■ HEADPHONE THEATER **DCS**

Allows you to experience a theater-like environment while listening through a pair of headphones.

To turn off the surround effect

Press 2CH, or press A.F.D. to select “A.F.D. AUTO”.

Enjoying the surround effect at low volume level (NIGHT MODE)

(STR-DA5000ES only)

This function allows you to retain a theater like environment at low volume levels. This function can be used with other sound fields.

When watching a movie late at night, you will be able to hear the dialog clearly even at a low volume level.

RM-LJ312

- 1** Press < repeatedly to select the **RECEIVER** menu.
- 2** Move the easy scroll key to select “**NIGHT MODE**”, then press the key to enter the selection.

The NIGHT MODE function is activated.

Tip

While this function is on, the BASS, TREBLE, and EFFECT level increase, and “D.RANGE COMP.” is automatically set to “MAX” (page 46).

Note

This function cannot be activated when MULTI CH IN or DIRECT function is activated.

Listening to the sound without any adjustment

You can listen to the sound without adjusting the equalizer and surround effect.

Press DIRECT.

The DIRECT indicator lights up and the equalizer and sound fields are canceled.

Selecting the surround back decoding mode

— SURR BACK DECODING

This function lets you select the decoding mode for the surround back signals of the multi channel input stream.

By decoding the surround back signal of DVD software (etc.) recorded in Dolby Digital EX, DTS-ES Matrix, DTS-ES Discrete 6.1, etc. format, you can enjoy the surround sound intended by the filmmakers.

Press SURR BACK DECODING repeatedly to select the surround back decoding mode.

For details, see “How to select the surround back decoding mode” on page 37.

Tip

You can select the surround back decoding mode using “SB DECODING” in the CUSTOMIZE menu (page 42).

How to select the surround back decoding mode

You can select the surround back mode you want according to the input stream.

When you select “AUTO”

When the input stream contains the 6.1 channel decode flag^{a)}, the appropriate decoder is applied to decode the surround back signal.

Input stream	Output channel	Applied surround back decoder
Dolby Digital 5.1	5.1 ^{e)}	—
Dolby Digital EX ^{b)}	6.1 ^{e)}	Matrix decoder conforms to Dolby Digital EX
DTS 5.1	5.1 ^{e)}	—
DTS-ES Matrix 6.1 ^{c)}	6.1 ^{e)}	DTS Matrix decoder
DTS-ES Discrete 6.1 ^{d)}	6.1 ^{e)}	DTS Discrete decoder

When you select “MATRIX”

Dolby Digital EX is applied to decode the surround back signal regardless of the 6.1 channel decode flag^{a)} in the input stream. This decoder conforms to Dolby Digital EX and functions the same as the decoders^{f)} used in movie theaters.

Input stream	Output channel	Applied surround back decoder
Dolby Digital 5.1	6.1 ^{e)}	Matrix decoder conforms to Dolby Digital EX
Dolby Digital EX ^{b)}	6.1 ^{e)}	Matrix decoder conforms to Dolby Digital EX
DTS 5.1	6.1 ^{e)}	Matrix decoder conforms to Dolby Digital EX
DTS-ES Matrix 6.1 ^{c)}	6.1 ^{e)}	Matrix decoder conforms to Dolby Digital EX
DTS-ES Discrete 6.1 ^{d)}	6.1 ^{e)}	Matrix decoder conforms to Dolby Digital EX

When you select “OFF”

Surround back decoding is not performed.

- a) 6.1 channel decode flag is the information recorded in software like DVDs.
- b) Dolby Digital DVD that includes a Surround EX flag. The Dolby Corporation web page can help you distinguish Surround EX films.
- c) Software encoded with a flag to denote it has both Surround EX and 5.1 channel signals.
- d) Software encoded with both 5.1 channel signals and an extension stream designed for returning those signals to 6.1 discrete channels. Discrete 6.1 channel signals are DVD specific signals not used in movie theaters.
- e) When two surround back speakers are connected, the output channel will be 7.1 channels (except for STR-DA3000ES models of area code CEL, TW).
- f) This decoder can be used for all 6.1 formats (Dolby Digital EX, DTS-ES Matrix 6.1, DTS-ES Discrete 6.1).

Note

There may be no sound from the surround back speaker in Dolby Digital EX mode. Some discs have no Dolby Digital EX flag even though the packages have Dolby Digital EX logos. In this case, select “MATRIX”.

Advanced Adjustments and Settings

Assigning the audio input

— DIGITAL ASSIGN

You can assign the digital audio input for other input. This function is convenient in the following cases.

(Example) When you have two DVD players and no digital audio input jack is available for the second DVD player.

Connect the first DVD player to the DVD COAXIAL IN jack and connect the second DVD player to the DVD OPTICAL IN jack. Also, connect the analog audio/video output jacks on the second DVD player to the VIDEO 2 INPUT jacks on the receiver.

Assign “DVD COAX” to DVD and assign “DVD OPT” to VIDEO 2.

- 1** Rotate MAIN MENU to select “CUSTOMIZE”.
- 2** Rotate MENU to select “DIGITAL ASSIGN ?”.
- 3** Press MEMORY/ENTER.
- 4** Rotate MENU to select the digital audio input you want to assign.
- 5** Rotate -/+ to select the input you want to assign the digital audio input jack selected in step 4.

The input you can assign varies for each audio input. For details, see “Selectable audio inputs for each input”.

Selectable audio inputs for each input

VIDEO 3 OPT

VIDEO 3, VIDEO 1, VIDEO 2, TAPE

DVD COAX, DVD OPT

DVD, VIDEO 1, VIDEO 2, TAPE

TV/SAT OPT

TV/SAT, VIDEO 1, VIDEO 2, TAPE

MD/DAT OPT

MD/DAT, VIDEO 1, VIDEO 2, TAPE

CD/SACD COAX, CD/SACD OPT

CD/SACD, VIDEO 1, VIDEO 2, TAPE

Notes

- You cannot assign several audio inputs to the same input.
- You cannot use the audio input for the original input when it is assigned to another input.
- When you assign the audio input, the INPUT MODE setting may change automatically (page 39).
- You cannot assign for TUNER.

Switching the audio input mode for digital components

— INPUT MODE

You can switch the audio input mode for components for which this receiver have digital audio input jacks.

- 1** Rotate **INPUT SELECTOR** to select the input.
- 2** Press **INPUT MODE** repeatedly to select the audio input mode.

The selected audio input mode appears in the display.

Audio input modes

- **AUTO 2CH**
Gives priority to the analog audio signals input to the **AUDIO IN (L/R)** jacks when there is no digital audio signals.
- **COAXIAL FIXED**
Specifies the digital audio signals input to the **DIGITAL COAXIAL** input jack.
- **OPTICAL FIXED**
Specifies the digital audio signals input to the **DIGITAL OPTICAL** input jacks.
- **ANALOG 2CH FIXED**
Specifies the analog audio signals input to the **AUDIO IN (L/R)** jacks.

Notes

- You cannot select the digital audio input which is assigned to another function by **DIGITAL ASSIGN** function (page 38).
- Some of the audio input modes do not appear depending on the input.

Customizing sound fields

By adjusting the **SURR SET UP** menu and **LEVEL** menu, you can customize the sound fields to suit your particular listening situation.

Note on the displayed items

The setup items you can adjust in each menu vary depending on the sound field. Certain setup parameters may be dimmed in the display. This means that the selected parameter is either unavailable or fixed and unchangeable.

Adjusting the SURR SET UP menu

You can customize the surround effects of the selected sound field. The settings are stored individually for each sound field.

- 1** Start playing a source encoded with multi channel surround effects (DVD, etc.).
- 2** Rotate **MAIN MENU** to select “**SURR SET UP**”.
- 3** Rotate **MENU** to select the parameter.
For details, see “**SURR SET UP** menu parameters” below.
- 4** While monitoring the sound, rotate **-/+** to adjust the selected parameter.
- 5** Repeat steps 3 and 4 to adjust the other parameters.

SURR SET UP menu parameters

■ EFFECT LEVEL XXX% (Effect level)

Initial setting: 100%

Higher settings apply more surround effect. You can adjust from 20 % to 120 % in 5 % steps.

For advanced SURR SET UP menu adjustments

Use the **CUSTOMIZE** menu and set “**MENU EXPAND**” to “**ON**” to enable advanced adjustments.

For details on “**MENU EXPAND**”, see page 42.

For details on how to set the items, see page 45.

Adjusting the LEVEL menu

You can adjust the balance and level of each speaker. These settings are applied to all sound fields.

- 1 Start playing a source encoded with multi channel surround effects (DVD, etc.).**
- 2 Rotate MAIN MENU to select “LEVEL”.**
- 3 Rotate MENU to select the parameter.**
For details, see “LEVEL menu parameters” below.
- 4 While monitoring the sound, rotate \pm to adjust the selected parameter.**
- 5 Repeat steps 3 and 4 to adjust the other parameters.**

LEVEL menu parameters

■ TEST TONE (Test Tone)

Initial setting: OFF

Lets you output the test tone sequentially from each speaker. When set to “AUTO”, the test tone is output from each speaker automatically. When set to “FIX”, you can select which speaker will output the test tone.

■ FRONT L_I_R (Front speaker balance)

Initial setting: 0 (BALANCE)

Lets you adjust the balance between front left and right speakers. You can adjust from -8 dB to $+8$ dB in 0.5 dB steps.

■ CENTER XXX.X dB (Center speaker level)

■ SURROUND L XXX.X dB (Surround speaker (L) level)

■ SURROUND R XXX.X dB (Surround speaker (R) level)

■ SURR BACK XXX.X dB (Surround back speaker level)*

■ SURR BACK L XXX.X dB (Surround back (L) level)**

■ SURR BACK R XXX.X dB (Surround back (R) level)**

■ SUB WOOFER XXX.X dB (Sub woofer level)

Initial setting: 0 dB

You can adjust from -20 dB to $+10$ dB in 0.5 dB steps.

■ MULTI CH 1 SW XXX dB (Multi channel 1 sub woofer level)

■ MULTI CH 2 SW XXX dB (Multi channel 2 sub woofer level)

Initial setting: 0 dB

Lets you increase the level of the MULTI CHANNEL INPUT 1/MULTI CHANNEL INPUT 2 sub woofer channel by $+10$ dB. This adjustment may be necessary when connecting a DVD player to the MULTI CHANNEL INPUT 1/MULTI CHANNEL INPUT 2 jacks. The sub woofer level from DVD players is 10 dB lower than Super Audio CD players.

* Only when the surround back speaker is set to “SINGLE” or “YES” in the SPEAKER SET UP menu (page 20).

*Only when the surround back speaker is set to “DUAL” in the SPEAKER SET UP menu (except for STR-DA3000ES models of area code CEL, TW) (page 20).

Note

When one of the following sound fields are selected, no sound is output from the sub woofer if all the speakers are set to “LARGE” in the SPEAKER SET UP menu. However, the sound will be output from the sub woofer if the digital input signal contains LFE (Low Frequency Effect) signals, or if the front or surround speakers are set to “SMALL”.

- D.CONCERT HALL A
- D.CONCERT HALL B
- CHURCH
- JAZZ CLUB
- LIVE CONCERT
- STADIUM
- SPORTS

For advanced LEVEL menu adjustments

Use the CUSTOMIZE menu and set “MENU EXPAND” to “ON” to enable advanced adjustments.

For details on “MENU EXPAND”, see page 42.
For details on how to set the items, see page 46.

Resetting sound fields to the initial settings

- 1 Press I/⏻ to turn off the power.**
- 2 While holding down MUSIC, press I/⏻.**

“S.F. Initialize” appears in the display and all sound fields are reset to the initial setting.

Adjusting the equalizer

You can adjust the tonal quality (bass, treble level) of each speaker using the EQUALIZER menu.

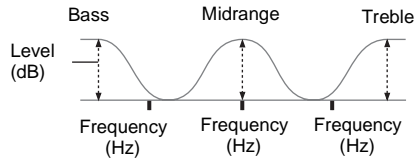

You can store up to 5 different equalizer settings in the equalizer bank (EQ PRESET [1]–[5]) and apply them.

- 1** Start playing a source encoded with multi channel surround effects (DVD, etc.).
- 2** Rotate MAIN MENU to select “EQUALIZER”.
- 3** Rotate MENU to select “EQ PRESET”.
- 4** Rotate $-/+$ to select the equalizer bank you want to adjust (EQ PRESET [1] – [5]).
- 5** Rotate MENU to select the parameter.
For details, see “EQUALIZER menu parameters” below.
- 6** While monitoring the sound, rotate $-/+$ to adjust the selected parameter.
- 7** Repeat steps 5 and 6 to adjust the other items.

EQUALIZER menu parameters

- EQ PRESET (Preset equalizer selection)
- FRONT BASS XXX dB
(Front speaker bass level)
- FRONT TREBLE XXX dB
(Front speaker treble level)
- CENTER BASS XXX dB
(Center speaker bass level)
- CENTER MID XXX dB
(Center speaker midrange level)

Initial setting: 0 dB

You can adjust from -10 dB to $+10$ dB in 1 dB steps.

■ **CENTER MID XXX Hz**
(Center speaker midrange frequency)

Initial setting: 1 kHz

You can adjust from 100 Hz to 10 kHz in 5 steps (100 Hz, 300 Hz, 1 kHz, 3 kHz, 10 kHz).

■ **CENTER TREBLE XXX dB**
(Center speaker treble level)

■ **SURR/SB BASS XXX dB**
(Surround/surround back speaker bass level)

■ **SURR/SB TRE. XXX dB**
(Surround/surround back speaker treble level)

Initial setting: 0 dB

You can adjust from -10 dB to +10 dB in 1 dB steps.

■ **PRESET X CLEAR**
(Equalizer bank clear)

You can reset the adjusted equalizer settings to the initial setting. For details, see “Clearing stored equalizer settings”.

Tip

You can adjust the front speaker bass and treble level with BASS control and TREBLE control.

To apply the stored equalizer

- 1 Rotate MAIN MENU to select “EQUALIZER”
- 2 Rotate MENU to select “EQ PRESET”.
- 3 Rotate +/- to select “EQ PRESET [1] – [5]”.

Clearing stored equalizer settings

- 1 Rotate MAIN MENU to select “EQUALIZER”.
- 2 Rotate MENU to select “EQ PRESET”.
- 3 Rotate +/- to select the equalizer (EQ PRESET [1] – [5]) you want to clear.
- 4 Rotate MENU to select “PRESET X CLEAR”.
“X” is the number of the selected equalizer bank.
- 5 Rotate +/- to select “YES”, then press MEMORY/ENTER.
“Are you sure?” appears in the display.
- 6 Rotate +/- to select “YES”, then press MEMORY/ENTER.

“PRESET X CLEARED!” appears in the display and the adjusted contents of the selected equalizer bank are cleared.

Advanced settings

Using the CUSTOMIZE menu to adjust the receiver

You can adjust various receiver settings using the CUSTOMIZE menu.

- 1 Rotate MAIN MENU to select “CUSTOMIZE”.
- 2 Rotate MENU to select the parameter.
For details, see “CUSTOMIZE menu parameters” below.
- 3 Rotate +/- to adjust the selected parameter.
- 4 Repeat steps 2 and 3 to adjust the other items.

CUSTOMIZE menu parameters

The initial setting is underlined.

■ **MENU EXPAND (Menu expanding)**

- ON

The advanced parameters for the SPEAKER SET UP, SURR SET UP and LEVEL menus are displayed and can be adjusted.

For details on each setup item, see pages 19, 39, 40 and the following pages.

- OFF

The advanced parameters are not displayed.

■ **DTS 96/24 DEC. (DTS 96/24 decoding mode)**

- AUTO

When a DTS 96/24 signal is input, it is played back at 96 kHz sampling frequencies.

- OFF

Even when a DTS 96/24 signal is input, it is played back at 48 kHz sampling frequencies.

Note

This parameter is valid only in the A.F.D. mode (page 33). In other sound fields, this parameter is always set to “OFF”.

■ **SB DECODING**
(Surround back decoding mode)

You can use the CUSTOMIZE menu to set the surround back decoding mode. See page 36.

- AUTO
- MATRIX
- OFF

■ LIP SYNC (Time alignment) (STR-DA5000ES only)

Initial setting: 0 ms

Lets you delay the output of audio to adjust the gap between video and audio. You can adjust from 0 ms to 200 ms in 10 ms steps.

■ DC P.LINEARIZER (Phase Linearizing)

Lets you change the phase polarity of low frequency signals and enhance the bass.

- OFF

The bass is not enhanced.

- STD

- MID

- HI

The bandwidth range of the phase correction increases in the order of “STD”, “MID”, “HI”.

■ S.FIELD LINK (Sound field link)

- ON

Lets you apply the last selected sound field to an input whenever it is selected. For example, if you select STADIUM for the CD/SACD input, then change to a different input and return to CD/SACD, STADIUM will automatically be applied again.

- OFF

Sound field link is not activated.

■ DEC. PRIORITY (Digital audio input decoding priority)

Lets you specify the input mode for the digital signal input to the DIGITAL IN jacks.

The initial setting is “AUTO” for VIDEO 1, VIDEO 2, VIDEO 3 and TV/SAT, and “PCM” for DVD, TAPE, MD/DAT, CD/SACD, TUNER and PHONO. You can use DECODE PRIORITY on the front panel.

- AUTO

Automatically switches the input mode between DTS, Dolby Digital, or PCM.

- PCM

PCM signals are given priority (to prevent the interruption when playback starts). Even when other signals are input, the sound is output. When set to “AUTO” and the sound from the digital audio jacks (for CD, etc.) is interrupted when playback starts, set to “PCM”.

■ 2 WAY REMOTE (2 way remote control system)

- ON

Lets you turn on the 2 way remote control system. Normally, select “ON”.

- OFF

Lets you turn off the 2 way remote control system. When you use another receiver, etc. that is also compatible with the 2 way remote control system, together with this receiver, select the component for

which you use the 2 way remote control system.

Then set the 2 way remote control system for the component to “ON”. For other components, set the 2 way remote control system to “OFF”.

■ COLOR SYSTEM (OSD color system) (Models of area code CEL only)

Lets you select the color system.

- NTSC

- PAL

■ OSD H.POSITION (OSD horizontal position)

Initial setting: 4

Lets you adjust the position of the on-screen display horizontally. You can adjust from 0 to 64.

■ OSD V.POSITION (OSD vertical position)

Initial setting: 4

Lets you adjust the position of the on-screen display vertically. You can adjust from 0 to 32.

■ DIMMER (Brightness of the display)

Lets you adjust the brightness of the display in 3 steps. For STR-DA3000ES, DIMMER indicator lights up. When you set to turn off the display completely, the MULTI CHANNEL DECODING indicator is also turned off.

■ UP YUV HUE (Video hue level)

Initial setting: 4

Lets you adjust the hue of the images when you upconvert the video or S-video signals to component video signals. You can adjust from 1 to 7.

■ UP YUV SHARPNESS (Video sharpness level)

Initial setting: 4

Lets you adjust the sharpness of the images when you upconvert the video or S-video signals to component video signals. You can adjust from 1 to 7.

■ UP YUV COLOR (Video chroma level)

Initial setting: 4

Lets you adjust the chroma of the images when you upconvert the video or S-video signals to component video signals. You can adjust from 1 to 7.

■ DIGITAL ASSIGN ? (Digital audio input assignment)

Lets you assign the digital audio input to other input. For details, see “Assigning the audio input” on page 38.

■ USER PRESET MEM.? (User preset memory)

Lets you store the adjusted sound field settings, etc. For details, see “Storing the adjusted settings” on page 48.

continued

■ **NAME IN?**
(Naming inputs)

Lets you set the name of inputs selected with INPUT SELECTOR. For details, see “Naming preset stations and inputs” on page 49.

Advanced SPEAKER SET UP menu parameters

When “MENU EXPAND” is set to “ON”, all of the following parameters are displayed and adjustable.

See page 19 for the SPEAKER SET UP menu adjustments. Initial settings are underlined.

All SPEAKER SET UP menu parameters

SP EASY SET UP
SPEAKER PATTERN
SUB WOOFER
FRONT SP
CENTER SP
SURROUND SP
SURR BACK SP
FRONT XXX meter (feet)*
CENTER XXX meter (feet)*
SURROUND XXX meter (feet)*
SURR BACK XXX meter (feet)*
SUB WOOFER XXX meter (feet)*
DISTANCE UNIT**
SP POSI.**
SP CROSSOVER > XXX Hz

* Default unit is “feet” for models of area code U, CA. Default unit is “meter” for models of other area codes.

**Adjustable only when “MENU EXPAND” is set to “ON”.

■ **DISTANCE UNIT (Distance unit)**

Lets you select the unit of measure for setting distances.

- feet (default for models of area code U, CA)
The distance is displayed in feet.
- meter (default for models for models of other area codes)
The distance is displayed in meters.

■ **SP POSI.**
(Surround speaker position)*

Lets you specify the location of your surround speakers for proper implementation of the surround effects in the Cinema Studio EX modes (page 34).

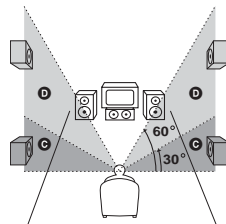
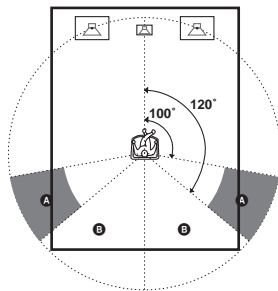

- **SIDE/LOW**
Select if the location of your surround speakers corresponds to section **A** and **C**.
- **SIDE/HIGH**
Select if the location of your surround speakers corresponds to section **A** and **D**.
- **BEHD/LOW**
Select if the location of your surround speakers corresponds to section **B** and **C**.
- **BEHD/HIGH**
Select if the location of your surround speakers corresponds to section **B** and **D**.

* This setup item is not available when the surround speaker parameter is set to “NO” (page 20).

Tip

Surround speaker position is designed specifically for implementation of the Cinema Studio EX modes. For other sound fields, speaker position is not so critical. Those sound fields were designed under the premise that the surround speakers would be located behind the listening position, but presentation remains fairly consistent even with the surround speakers positioned at a rather wide angle. However, if the speakers are pointing toward the listener from the immediate left and right of the listening position, the surround effects becomes unclear unless set to “SIDE”.

Nevertheless, each listening environment has many variables, like wall reflections, and you may obtain better results using “BEHD” if your speakers are located high above the listening position, even if they are to the immediate left and right.

Therefore, although it may result in a setting contrary to the above explanation, we recommend that you playback multi channel surround encoded software and select the setting that provides a good sense of spaciousness and that best succeeds in forming a cohesive space between the surround sound from the surround speakers and the sound of the front speakers. If you are not sure which sounds best, select “BEHD” and then use the speaker distance parameter and speaker level adjustments to obtain proper balance.

■ SP CROSSOVER > XXX Hz (Speaker crossover frequency)

Initial setting: 100 Hz

Lets you set the bass crossover frequency of speakers set to “SMALL” in the SPEAKER SET UP menu. You can adjust from 40 Hz to 160 Hz in 10 Hz steps.

Advanced SURR SET UP menu parameters

When “MENU EXPAND” is set to “ON”, all of the following parameters are displayed and adjustable.

See page 39 for the SURR SET UP menu adjustments. Initial settings are underlined.

All SURR SET UP menu parameters

EFFECT LEVEL

C. WIDTH L_C_R*

DIMENSION F_I_S*

PANORAMA MODE*

FRONT REVERB*

SCREEN DEPTH*

VIR.SPEAKERS*

A.F.D. 2CH SW*

* Adjustable only when “MENU EXPAND” is set to “ON”.

■ C. WIDTH L_C_R (Center width control)

Initial setting: (3)

Lets you perform further adjustments for Dolby Pro Logic II Music mode decoding. You can set this parameter only when A.F.D. mode is set to “PRO LOGIC II MUSIC” (page 33).

You can adjust the distribution of the center channel signal, generated through the Dolby Pro Logic II decoding, to the L/R speakers.

■ DIMENSION F_I_S (Dimension control)

Initial setting: midpoint (0)

Lets you perform further adjustments for Dolby Pro Logic II Music mode decoding. You can set this parameter only when A.F.D. mode is set to “PRO LOGIC II MUSIC” (page 33).

You can adjust the difference between the front channels and the surround channels.

■ PANORAMA MODE (Panorama mode)

Lets you perform further adjustments for Dolby Pro Logic II Music mode decoding. You can set this parameter only when A.F.D. mode is set to “PRO LOGIC II MUSIC” (page 33).

- ON

Lets you enjoy the surround sound by spreading the sound field of front speakers to the left and right of the listening position (panorama mode).

- OFF

Panorama mode is not activated.

■ FRONT REVERB (Front reverberation)

This parameter is especially for “D.CONCERT HALL A/B” (page 35). This parameter lets you adjust the amount of reverberations to add to the front signals according to the original reverberations in the source.

- STD

Normally, select “STD”.

- WET

Select to increase front reverberations.

■ SCREEN DEPTH (Screen depth)

Lets you create the sensation that the sound of the front speakers comes from inside the screen in your listening room, like theatres.

- ON

Lets you create the sensation that the sound comes from a very large screen with a great amount of screen depth.

- OFF

This function is not activated.

Note

This parameter is only available for Cinema Studio EX modes.

■ VIR.SPEAKERS (Virtual speakers)

This parameter is especially for the Cinema Studio EX modes (page 34).

- ON

The virtual speakers are created.

continued

- OFF

The virtual speakers are not created.

■ **A.F.D. 2CH SW**
(Creating, low frequency signals)

- CREATE

Lets you create low frequency signals for output to the subwoofer when “A.F.D. AUTO” is selected.

- OFF

Low frequency signals are not created.

Advanced LEVEL menu parameters

When “MENU EXPAND” is set to “ON”, all of the following parameters are displayed and adjustable.

See page 40 for the LEVEL menu adjustments. Initial settings are underlined.

All LEVEL menu parameters

TEST TONE
PHASE NOISE ^{a)}
PHASE AUDIO ^{a)}
FRONT L_I_R
CENTER XXX.X dB
SURROUND L XXX.X dB
SURROUND R XXX.X dB
SURR BACK XXX.X dB ^{b)}
SURR BACK L XXX.X dB ^{c)}
SURR BACK R XXX.X dB ^{c)}
SUB WOOFER XXX.X dB
MULTI CH 1 SW XXX dB
MULTI CH 2 SW XXX dB
D.RANGE COMP. ^{a)}

^{a)} Adjustable only when “MENU EXPAND” is set to “ON”.

^{b)} When surround back speaker is set to “SINGLE” or “YES” (page 20).

^{c)} When surround back speaker is set to “DUAL” (except for STR-DA3000ES models of area code CEL, TW) (page 20).

■ **PHASE NOISE (Phase noise)**

Initial setting: OFF

Lets you output the test tone sequentially from adjacent speakers.

■ **PHASE AUDIO (Phase audio)**

Initial setting: OFF

Lets you output the front 2 channel source sound (instead of the test tone) sequentially from adjacent speakers.

■ **D.RANGE COMP.**
(Dynamic range compressor)

Lets you compress the dynamic range of the sound track. This may be useful when you want to watch movies at low volumes late at night.

- OFF

The dynamic range is not compressed.

- STD

The dynamic range is compressed as intended by the recording engineer.

- MAX

The dynamic range is compressed dramatically.

Tip

Dynamic range compressor lets you compress the dynamic range of the soundtrack based on the dynamic range information included in the Dolby Digital signal. “STD” is the standard setting, but it only enacts light compression.

Therefore, we recommend using the “MAX” setting. This greatly compresses the dynamic range and lets you view movies late at night at low volumes. Unlike analog limiters, the levels are predetermined and provide a very natural compression.

Note

Dynamic range compression is possible with Dolby Digital sources only.

Custom install mode

(Models of area code U, CA only)

This receiver features the custom install modes described below. Depending on how you intend to use these features, use of these modes may require additional equipment (available separately) or modification of your listening environment. Please consult the retailer where you purchased this receiver for more information.

- 1 Rotate MAIN MENU to select “CIS”.**
- 2 Rotate MENU to select the parameter.**
For details, see “CIS menu parameters” below.
- 3 Rotate –/+ to select the setting you want.**
- 4 Repeat steps 2 and 3 to adjust the other items.**

CIS menu parameters

Initial settings are underlined.

- **2ND ZONE (2nd zone source)**
- **3RD ZONE (3rd zone source) (STR-DA5000ES only)**

Lets you select the source signals (analog audio and video signals for 2nd zone; only analog audio signals for 3rd zone) you want to output in the 2nd zone or 3rd zone (except PHONO). When you select “SOURCE”, the signals of the current input is output.

Tips

- Only signals from components connected to the analog input jacks are output through the 2ND ZONE or 3RD ZONE jacks. No signal is output from components connected to only the digital input jacks.
- When “SOURCE” is selected, the signals input to the MULTI CHANNEL INPUT jacks are not output from the 2ND ZONE or 3RD ZONE jacks even when MULTI CH IN function is used. The 2 channel analog audio signals of the current input is output.

■ INSTALLER MODE (RS232C control)

- **ON**
The receiver can receive commands from the RS232C port even when the power is off (standby mode).
- **OFF**
The receiver does not receive commands from the RS232C port when the power is off (standby mode).

- **12V TRIG. MAIN**
(12 V trigger for the main receiver)

- **12V TRIG. 2ND**
(12 V trigger for the 2nd zone)

- **12V TRIG. 3RD**
(12 V trigger for the 3rd zone)
(STR-DA5000ES only)

Lets you turn on or off the external equipment by outputting 12V triggers (STR-DA5000ES: 3 outputs, STR-DA3000ES: 2 outputs) when the receiver is turned on or off. For example, you can automatically unroll your video screen when you turn on the receiver.

- **OFF**
Lets you turn off output of 12V triggers even when the main receiver is turned on.
- **CTRL**
Lets you turn on or off the output of 12V triggers manually by the CIS command of the IR remote or RS232C control.
- **ZONE**
Lets you turn on output of 12V triggers when the main receiver or the receiver in each zone is turned on.
- **INPUT** (for “12V TRIG. MAIN” only)
Lets you turn on output of 12V triggers when the main receiver is turned on, depending on the setting of each input. See “To set the 12V trigger setting for each input”.
- **MAIN** (for “12V TRIG. 2ND” and “12V TRIG. 3RD” only)
Lets you link 2nd or 3rd zone trigger operation to the main receiver.

To set the 12V trigger setting for each input

The initial setting is “OFF” for all inputs. To set this setting, you can use only the controls on the front panel.

- 1** Select “INPUT” in “12V TRIG. MAIN”.
- 2** Press MEMORY/ENTER.
- 3** Rotate MENU to select the input.
- 4** Rotate –/+ to select “ON” to activate 12V trigger or select “OFF” to deactivate.
- 5** Press MEMORY/ENTER.

Storing the adjusted settings

— USER PRESET

You can store the adjusted sound field settings, etc. as USER PRESET up to 3 and can easily apply.

Setting the USER PRESET

- 1 Adjust the sound field, etc.**
For the settings you can store, see “Settings that can be stored in USER PRESET”.
- 2 Rotate MAIN MENU to select “CUSTOMIZE”.**
- 3 Rotate MENU to select “USER PRESET MEM.?”.**
- 4 Rotate $-/+$ to select the USER PRESET number.**
- 5 Press MEMORY/ENTER.**
- 6 To store other settings, repeat steps 1 to 5.**

Settings that can be stored in USER PRESET

- Input selected by the INPUT SELECTOR
- INPUT MODE setting
- Selected sound field
- MULTI CH IN setting
- DIRECT setting
- NIGHT MODE setting
- C.WIDTH setting
- DIMENSION setting
- PANORAMA MODE setting
- EFFECT LEVEL setting
- FRONT REVERB setting
- SCREEN DEPTH setting
- VIR.SPEAKERS setting
- Tuner settings (band, frequency, stereo/mono setting, preset number)

To use the USER PRESET

- 1 Press USER PRESET repeatedly to select the USER PRESET you want.**
- 2 Press MEMORY/ENTER.**

Note

When the DIGITAL ASSIGN setting is changed after you store a USER PRESET and if the stored INPUT MODE setting cannot be used, a selectable setting is applied automatically.

Example:

- 1) Use the DIGITAL ASSIGN function to assign “DVD OPT” to “TAPE”.
- 2) Set the INPUT MODE of TAPE to “AUTO 2CH” or “OPTICAL FIXED”, then store in the USER PRESET.
- 3) Use the DIGITAL ASSIGN function to assign “DVD OPT” to “DVD”.
- 4) Select the USER PRESET stored in example 2). The INPUT MODE of TAPE is automatically set to “ANALOG 2CH FIXED”. You cannot select “AUTO 2CH” or “OPTICAL FIXED”.

Other Operations

Naming preset stations and inputs

You can enter a name of up to 8 characters for preset stations and inputs selected with INPUT SELECTOR, and display it in the receiver's display.

To index a preset station

- 1 Rotate INPUT SELECTOR to select tuner ("FM" or "AM").
- 2 Press FM/AM to select "FM" or "AM".
- 3 Tune in the preset station you want to create an index name for (page 27).
- 4 Rotate MAIN MENU to select "TUNER".
- 5 Rotate MENU to select "NAME IN".
- 6 Press MEMORY/ENTER.

The cursor flashes and you can select a character. Follow the procedure of "To create an index name".

To index an input

- 1 Rotate INPUT SELECTOR to select an input you want to create an index name for.
- 2 Rotate MAIN MENU to select "CUSTOMIZE".
- 3 Rotate MENU to select "NAME IN?".
- 4 Press MEMORY/ENTER.

The cursor flashes and you can select a character. Follow the procedure of "To create an index name".

To create an index name

- 1 Use MENU and -/+ to create an index name.

Rotate -/+ to select a character, then rotate MENU to move the cursor to the next position.

Tips

- You can select the character type as follows by rotating -/+.
Alphabet (upper case) → Numbers → Symbols
- To enter a blank space, rotate -/+ until a blank space appears in the display.
- If you made a mistake, rotate MENU until the character you want to change flashes, then rotate -/+ to select the correct character.

2 Press MEMORY/ENTER.

The entered name is registered.

Note (Models of area code CEL only)

When you name an RDS station and tune in the station, the Program Service (PS) name appears instead of the name you entered. (You cannot change the name of a Program Service (PS) name. The name you entered will be overwritten by the Program Service (PS) name.)

Using the Sleep Timer

You can set the receiver to turn off automatically at a specified time by using the remote.

For details, refer to the operating instructions supplied with the remote.

RM-LJ312:

Select SLEEP from the RECEIVER menu, then press the key repeatedly while the power is on.

RM-LG112:

Press ALT, then press SLEEP repeatedly while the power is on.

Each time you select or press SLEEP, the display changes cyclically as follows:

2:00:00 → 1:30:00 → 1:00:00 → 0:30:00 → OFF

While using Sleep Timer, "SLEEP" lights up in the display.

Tip

To check the remaining time before the receiver turns off, select SLEEP from the RECEIVER menu (RM-LJ312) or press ALT, then press SLEEP (RM-LG112). The remaining time appears in the display.

Selecting the speaker system

Set the SPEAKERS switch according to the front speakers you want to drive.

Set to	To select
A	The speakers connected to the FRONT SPEAKERS A terminals.
B	The speakers connected to the FRONT SPEAKERS B terminals.
A+B	The speakers connected to both the FRONT SPEAKERS A and B terminals (parallel connection).
OFF	No speaker output.

Recording

Before you begin, make sure you have connected all components properly.

Recording on an audio tape or MiniDisc

You can record on a MiniDisc or cassette tape using the receiver. See the operating instructions of your cassette deck or MD deck if you need help.

- 1 Select the component to be recorded.**
- 2 Prepare the component for playing.**
For example, insert a CD into the CD player.
- 3 Insert a blank tape or MD into the recording deck and adjust the recording level, if necessary.**
- 4 Start recording on the recording deck, then start playback on the playback component.**

Notes

- You cannot record a digital audio signal using a component connected to the analog TAPE OUT or MD/DAT OUT jacks. To record a digital audio signal, connect a digital component to the MD/DAT OPTICAL OUT jacks.
- Sound adjustments do not affect the signal output from the TAPE OUT or MD/DAT OUT jacks.
- The analog audio signals of the current input is output from the TAPE OUT or MD/DAT OUT jacks.
- The signals input to the MULTI CHANNEL INPUT jacks are not output from the TAPE OUT or MD/DAT OUT jacks even when MULTI CH IN is being used. The analog audio signals of the current or previously used input are output.

Recording on a video tape

You can record from a VCR, a TV, or an LD player using the receiver. You can also add audio from a variety of audio sources when editing a video tape. See the operating instructions of your VCR if you need help.

- 1 Select the program source to be recorded.**

- 2 Prepare the component for playing.**

For example, insert the laser disc you want to record into the LD player.

- 3 Insert a blank video tape into the VCR (VIDEO 1 or VIDEO 2) for recording.**

- 4 Start recording on the recording VCR, then start playing the video tape or laser disc you want to record.**

Notes

- You cannot record a digital audio signal using a component connected to the analog VIDEO 1 OUT or VIDEO 2 OUT jacks.
- Make sure to make both digital and analog connections to the TV/SAT or DVD inputs. Analog recording is not possible if you make only digital connections.
- Some sources contain copy guards to prevent recording. In this case, you may not be able to record from the sources.
- The analog audio signals of the current input are output from the VIDEO 1 OUT or VIDEO 2 OUT jacks.
- The signals input to the MULTI CHANNEL INPUT jacks are not output from VIDEO 1 OUT or VIDEO 2 OUT jacks even when MULTI CH IN is being used. The analog audio signals of the current or previously used input are output.

Listening to the sound in another zone

(Models of area code U, CA only)

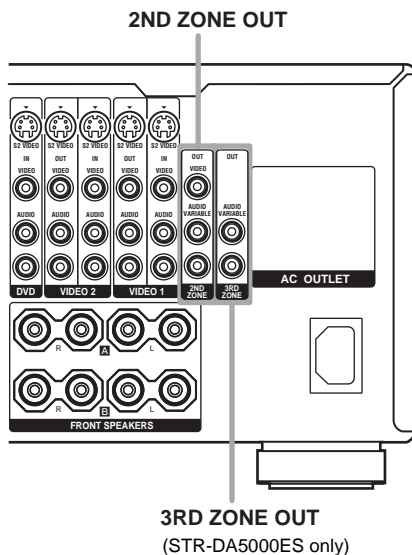

You can select analog audio/video signals for output to the 2nd zone or audio signals for the 3rd zone (STR-DA5000ES only). For details on the connection, see page 53.

Use the remote RM-US106 for the operation.

1 On the remote, press **2ND ZONE** or **3RD ZONE** (STR-DA5000ES only).

The remote switches to the 2nd zone or 3rd zone (STR-DA5000ES only) mode. For details on the supplied remote, refer to the operating instructions supplied with the remote.

2 Turn on the main receiver (this receiver).

3 Turn on the amplifier in the 2nd or 3rd zone.

4 Press one of the input buttons on the remote to select the source signals you want to output.

For the 2nd zone, analog video and audio signals are output. For the 3rd zone (STR-DA5000ES only), only analog audio

signals are output. When you select “SOURCE”, the signals of the current input are output.

5 Press **MASTER VOL +/-** on the remote to adjust the volume of the 2nd zone or 3rd zone.

The default setting of the volume is $-\infty$ dB (no sound output).

Tips

- Even when this receiver is turned off, the receiver in the 2nd zone or 3rd zone remains turned on. To turn off all receivers, press **I/⏻** and **AV I/⏻** on the remote at the same time (SYSTEM STANDBY).
- Only signals from components connected to the analog input jacks are output through the 2ND ZONE OUT or 3RD ZONE OUT (STR-DA5000ES only) jacks. No signals are output from components connected to only the digital input jacks.
- When “SOURCE” is selected, the signals input to the MULTI CH IN jacks are not output from the 2ND ZONE OUT or 3RD ZONE OUT (STR-DA5000ES only) jacks even when MULTI CH IN is selected. The analog audio signals of the current function are output.

2nd zone connections

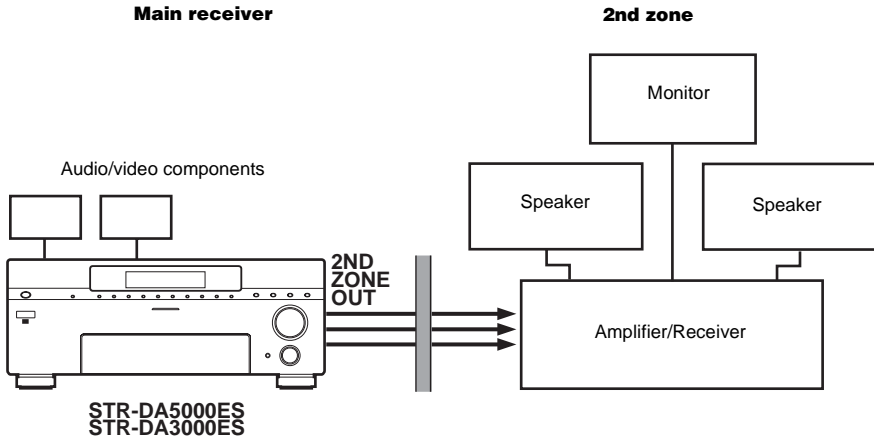

3rd zone connections

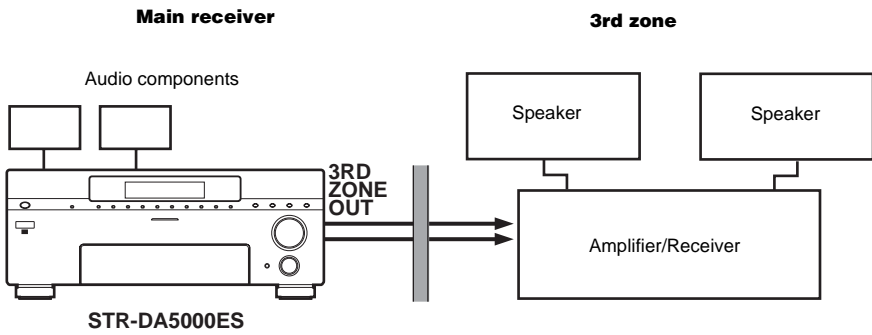

CONTROL A1II Control System

The CONTROL A1II Control System was designed to simplify the operation of audio systems composed of separate Sony components. CONTROL A1II connections provide a path for the transmission of control signals which enable automatic operation and control features usually associated with integrated systems. Currently, CONTROL A1II connections between a Sony CD player, amplifier (receiver), MD deck and cassette deck provide automatic function selection.

Note

Do not operate a 2 way remote control unit when the CONTROL A1II jacks are connected via a PC interface kit to a personal computer running "MD Editor" or similar application. Also, do not operate the connected component in a manner contrary to the functions of the application, as this may cause the application to operate incorrectly.

CONTROL A1II and CONTROL A1 compatibility

The CONTROL A1 control system has been updated to the CONTROL A1II which is the standard system in the Sony 300 disc CD changer and other recent Sony components. Components with CONTROL A1 jacks are compatible with components with CONTROL A1II, and can be connected to each other. Basically, the majority of the functions available with the CONTROL A1 control system will be available with the CONTROL A1II control system.

However, when making connections between components with CONTROL A1 jacks and components with CONTROL A1II jacks, the number of functions that can be controlled may be limited depending on the component. For detailed information, refer to the operating instructions supplied with the component(s).

If you have a Sony CD changer with a COMMAND MODE selector

If your CD changer's COMMAND MODE selector can be set to CD 1, CD 2, or CD 3, be sure to set the command mode to "CD 1" and connect the changer to the CD jacks on the amplifier (receiver).

If, however, you have a Sony CD changer with VIDEO OUT jacks, set the command mode to "CD 2" and connect the changer to the VIDEO 2 jacks on the amplifier (receiver).

Connections

You can connect up to 10 CONTROL A1II compatible components in any order. However, you can connect only one of each type of component (i.e., 1 CD player, 1 MD deck, 1 tape deck and 1 receiver).

(You may be able to connect more than one CD player or MD deck, depending on the model. Refer to the operating instructions supplied with the respective component for details.)

Example

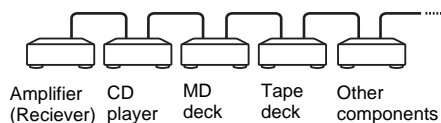

In the CONTROL A1II control system, the control signals flow both ways, so there is no distinction of IN and OUT jacks. If a component has more than one CONTROL A1II jack, you can use either one, or connect different components to each jack.

Some CONTROL A1 compatible components are supplied with a connecting cord as an accessory. In this case, use the connecting cord for your connection.

When using a commercially available cord, use a monaural (2P) mini-plug cord less than 2 meters long, with no resistance.

Basic Functions

The input selector on the receiver automatically switches to the correct input when you press the play button on one of the connected components (Auto input selection).

The CONTROL A1II functions will operate as long as the component you want to operate is turned on, even if all of the other connected components are not turned on.

Note

When recording, do not play any components other than the recording source. It will cause the automatic input selection to operate.

Using CONTROL S Control System

(Models of area code U, CA only)

If you have a CONTROL S-compatible Sony TV, satellite tuner, monitor, DVD player or VCR, use a control S connecting cord (not supplied) to connect the CTRL S IN (for TV, satellite tuner, or monitor) or CTRL S OUT (for VCR, etc.) jack on the receiver to the appropriate CONTROL S jack on the respective component. Refer to the operating instructions supplied with your TV, satellite tuner, monitor, VCR, etc., for details.

If you connect the CTRL S OUT jack on another component to the CTRL S IN jack on this unit

Example

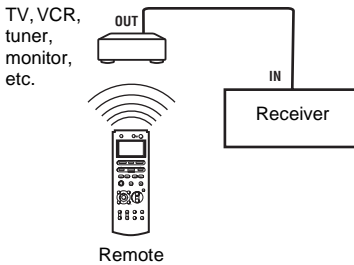

The remote sensor on the CTRL S OUT component receives remote codes the same way as the remote sensor on this unit. This is useful if you have placed this unit in a rack, etc.

If you connect the CTRL S IN jack on another component to the CTRL S OUT jack on this unit

Example

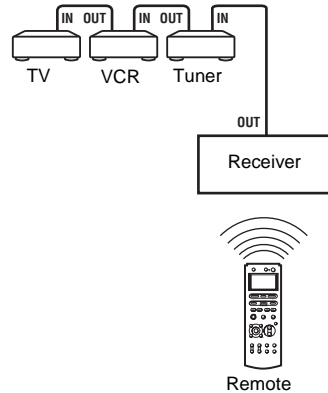

The remote sensor on this unit receives remote codes the same way as the remote sensor on the CTRL S IN component. This is useful if you place the other component away from this unit.

Additional Information

Precautions

On safety

Should any solid object or liquid fall into the cabinet, unplug the receiver and have it checked by qualified personnel before operating it any further.

On power sources

- Before operating the unit, check that the operating voltage is identical with your local power supply. The operating voltage is indicated on the nameplate at the rear of the receiver.
- The unit is not disconnected from the AC power source (mains) as long as it is connected to the wall outlet, even if the unit itself has been turned off.
- If you are not going to use the receiver for a long time, be sure to disconnect the receiver from the wall outlet. To disconnect the AC power cord, grasp the plug itself; never pull the cord.
- (Models of area code U, CA only)
One blade of the plug is wider than the other for the purpose of safety and will fit into the wall outlet only one way. If you are unable to insert the plug fully into the outlet, contact your dealer.
- AC power cord must be changed only at the qualified service shop.

On heat buildup

Although the unit heats up during operation, this is not a malfunction. If you continuously use this unit at a large volume, the cabinet temperature of the top, side and bottom rises considerably. To avoid burning yourself, do not touch the cabinet.

On placement

- Place the receiver in a location with adequate ventilation to prevent heat buildup and prolong the life of the receiver.
- Do not place the receiver near heat sources, or in a place subject to direct sunlight, excessive dust or mechanical shock.
- Do not place anything on top of the cabinet that might block the ventilation holes and cause malfunctions.

On operation

Before connecting other components, be sure to turn off and unplug the receiver.

On cleaning

Clean the cabinet, panel and controls with a soft cloth slightly moistened with a mild detergent solution. Do

not use any type of abrasive pad, scouring powder or solvent such as alcohol or benzine.

If you have any question or problem concerning your receiver, please consult your nearest Sony dealer.

Troubleshooting

If you experience any of the following difficulties while using the receiver, use this troubleshooting guide to help you remedy the problem. Should any problem persist, consult your nearest Sony dealer.

There is no sound no matter which component is selected.

- Check that both the receiver and all components are turned on.
- Check that the MASTER VOLUME control is not set at $-\infty$ dB.
- Check that the SPEAKERS is not set to “OFF” (page 50).
- Check that all speaker cords are connected correctly.
- Press MUTING on the remote to cancel the muting function.

There is no sound from a specific component.

- Check that the component is connected correctly to the audio input jacks for that component.
- Check that the cord(s) used for the connection is (are) fully inserted into the jacks on both the receiver and the component.

There is no sound from one of the front speakers.

- Connect a pair of headphones to the PHONES jack to verify that sound is output from the headphones. If only one channel is output from the headphones, the component may not be connected to the receiver correctly. Check that all the cords are fully inserted into the jacks on both the receiver and the component. If both channels are output from the headphones, the front speaker may not be connected to the receiver correctly. Check the connection of the front speaker which is not outputting any sound.
- Make sure you have not connected only the L or R jack to a monaural component. Use a monaural-stereo cable (not supplied) and connect it to both the L and R jacks. However, there will be no sound from the center speaker when a sound field (PRO LOGIC, etc.) is selected. When the center speaker is set to “NO”, sound is output only from front L/R speakers.

There is no sound or only a very low-level sound is heard.

- Check that the speakers and components are connected securely.

- Check that you have selected the correct component with INPUT SELECTOR.
- Check that the SPEAKERS is not set to “OFF” (page 50).
- Check that the headphones are not connected.
- Press MUTING on the remote to cancel the muting function.
- When only a very low-level sound is heard, check to see if NIGHT MODE is activated (page 36).
- The protective device on the receiver has been activated. Turn off the receiver, eliminate the short-circuit problem and turn on the power again.

There is no sound from analog 2 channel sources.

- Check that the DIGITAL ASSIGN function is not used to assign the audio input of other input to the selected input (page 38).
- Check that the INPUT MODE is not set to “COAXIAL FIXED” nor “OPTICAL FIXED” for the selected input (page 39).
- Check that the MULTI CH IN function is selected.

There is no sound from digital sources (from COAXIAL or OPTICAL input jack).

- Check that the DIGITAL ASSIGN function is not used to assign the audio input of other input to the selected input (page 38).
- Check that the INPUT MODE is not set to “ANALOG 2CH FIXED” (page 39). Check that the INPUT MODE is not set to “COAXIAL FIXED” for the sources from OPTICAL input jack, nor set to “OPTICAL FIXED” for the sources from COAXIAL input jack.
- Check that the MULTI CH IN function is selected.

The left and right sounds are unbalanced or reversed.

- Check that the speakers and components are connected correctly and securely.
- Adjust balance parameters in the LEVEL menu.

There is severe hum or noise.

- Check that the speakers and components are connected securely.
- Check that the connecting cords are away from a transformer or motor, and at least 3 meters away from a TV set or fluorescent light.
- Move your TV away from the audio components.
- Make sure you have grounded the SIGNAL GND terminal (only when a turntable is connected).
- The plugs and jacks are dirty. Wipe them with a cloth slightly moistened with alcohol.

There is no sound from the center speaker.

- Make sure the sound field function is on (press A.F.D., MOVIE or MUSIC).
- Select the CINEMA STUDIO EX mode (page 34).
- Adjust the speaker level (page 40).
- Make sure the center speaker is set to either “SMALL” or “LARGE” (page 20).

There is no sound from the surround back speakers.

- Some discs have no Dolby Digital EX flag even though the packages have Dolby Digital EX logos. In this case, select “MATRIX” (page 37).

There is no sound or only a very low-level sound is heard from the surround/surround back speakers.

- Make sure the sound field function is on (press A.F.D., MOVIE or MUSIC).
- Select a CINEMA STUDIO EX mode (page 34).
- Adjust the speaker level (page 22).
- Make sure the surround speakers are set to either “SMALL” or “LARGE” (page 20).
- Make sure the surround back speaker is set to either “DUAL” or “SINGLE” (except for STR-DA3000ES models of area code CEL, TW), or “YES” (STR-DA3000ES models of area code CEL, TW only).

There is no sound from sub woofer.

- When all speakers are set to “LARGE” and “Neo:6 Cinema” or “Neo:6 Music” is selected, there is no sound from the sub woofer.

The surround effect cannot be obtained.

- Make sure the sound field function is on (press A.F.D., MOVIE or MUSIC).
- Sound fields do not function for the signals with a sampling frequency of more than 48 kHz.

Dolby Digital or DTS multi channel sound is not reproduced.

- Check that the playing DVD, etc. is recorded in Dolby Digital or DTS format.
- When connecting the DVD player, etc. to the digital input jacks of this receiver, check the audio setting (settings for the audio output) of the connected component.

Recording cannot be done.

- Check that the components are connected correctly.
- Select the source component with INPUT SELECTOR.

The FM reception is poor.

- Use a 75-ohm coaxial cable (not supplied) to connect the receiver to an outdoor FM antenna as shown below. If you connect the receiver to an outdoor antenna, ground it against lightning. To prevent a gas explosion, do not connect the ground wire to a gas pipe.

Outdoor FM antenna

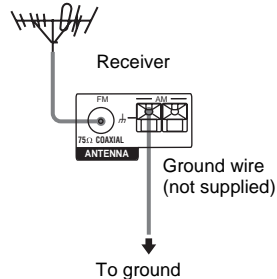

Radio stations cannot be tuned in.

- Check that the antennas are connected securely. Adjust the antennas and connect an external antenna if necessary.
- The signal strength of the stations is too weak (when tuning in with automatic tuning). Use direct tuning.
- Make sure you set the tuning interval correctly (when tuning in AM stations with direct tuning).
- No stations have been preset or the preset stations have been cleared (when tuning by scanning preset stations). Preset the stations (page 27).
- Press DISPLAY so that the frequency appears in the display.

RDS does not work.*

- Make sure that you're tuned to an FM RDS station.
- Select a stronger FM station.

The RDS information that you want does not appear.*

- Contact the radio station and find out whether or not they actually provide the service in question. If so, the service may be temporarily out of order.

There is no picture or an unclear picture appears on the TV screen or monitor.

- Select the appropriate input on the receiver.
- Set your TV to the appropriate input mode.
- Move your TV away from the audio components.
- Connect your TV to the receiver using the same type of connecting cord as the one used to connect the receiver and video component (pages 9 and 12).

Remote control

The remote does not function.

- Point the remote at the remote sensor on the receiver.
- Remove any obstacles in the path between the remote and the receiver.
- Replace all the batteries in the remote with new ones, if they are weak.
- Check if the command modes of the receiver and the remote is the same. If the command mode of the receiver and the remote is different, you cannot operate the receiver with the remote. To switch the command mode of the remote, press I/⏻ while pressing INPUT MODE. Each time you press I/⏻, the command mode switches between “COMAMND MODE [AV2]” and “COMAMND MODE [AV1]”. (The initial setting is “COMAMND MODE [AV2]”.) For STR-DA5000ES, the command mode of the remote is automatically set to match the receiver when you perform the AMP REGIST operation again.
- Make sure you select the correct input on the remote.

* Models of area code CEL only.

Error messages

If there is a malfunction, the display shows a code of two numbers and a message. You can check the condition of the system by the message. Refer to the following table to solve the problem. If any problem persists, consult your nearest Sony dealer.

DECODE ERROR/CHECK CODE 01

Appears when the signal which the receiver cannot decode (ex. DTS-CD) is input when “DEC. PRIORITY” in the CUSTOMIZE menu is set to “PCM”. Set to “AUTO”.

PROTECTOR/CHECK CODE 11

Irregular current is output from the speakers. Turn off the receiver, check the speaker connection and turn on the power again.

PROTECTOR/CHECK CODE 12

The amplifier section is overheated. Check that the ventilation hole is not covered. Turn off the receiver, leave the receiver for a while and turn on the power again.

PROTECTOR/CHECK CODE 13

The power section is overheated. Check that the ventilation hole is not covered. Turn off the

receiver, leave the receiver for a while and turn on the power again.

PROTECTOR/CHECK CODE 21

Turn off the receiver and consult your nearest Sony dealer.

PROTECTOR/CHECK CODE 22

There is a problem with the power circuit. Turn off the receiver and check the speaker connection. Then turn on the power again.

Reference sections for clearing the memory

To clear	See
All memorized settings	page 18
Customized sound fields	page 40

Specifications

AUDIO POWER SPECIFICATIONS

POWER OUTPUT AND TOTAL HARMONIC DISTORTION: (Models of area code U only)

STR-DA5000ES:

With 8 ohm loads, both channels driven, from 20 – 20,000 Hz; rated 170 watts per channel minimum RMS power, with no more than 0.6% total harmonic distortion from 250 milliwatts to rated output.

STR-DA3000ES:

With 8 ohm loads, both channels driven, from 20 – 20,000 Hz; rated 150 watts per channel minimum RMS power, with no more than 0.6% total harmonic distortion from 250 milliwatts to rated output.

Amplifier section

Models of area code U, CA, TW:

POWER OUTPUT

Rated Power Output at Stereo Mode¹⁾

(8 ohms 20 Hz – 20 kHz, THD 0.6%)

STR-DA5000ES: 170 W + 170 W

STR-DA3000ES: 150 W + 150 W

Reference Power Output at Stereo Mode

(4 ohms 20 Hz – 20 kHz, THD 0.6%)

STR-DA5000ES: 150 W + 150 W

STR-DA3000ES: 130 W + 130 W

Reference Power Output

(8 ohms 20 Hz – 20 kHz, THD 0.6%)

STR-DA5000ES: FRONT²⁾: 170 W + 170 W

CENTER²⁾: 170 W

SURR²⁾: 170 W + 170 W

SURR BACK²⁾: 170 W + 170 W

STR-DA3000ES: FRONT²⁾: 150 W + 150 W

CENTER²⁾: 150 W

SURR²⁾: 150 W + 150 W

SURR BACK²⁾³⁾: 150 W +

150 W

SURR BACK²⁾⁴⁾: 150 W

(4 ohms 20 Hz – 20 kHz, THD 0.6%)

STR-DA5000ES: FRONT²⁾: 150 W + 150 W

CENTER²⁾: 150 W

SURR²⁾: 150 W + 150 W

SURR BACK²⁾: 150 W + 150 W

STR-DA3000ES: FRONT²⁾: 130 W + 130 W

CENTER²⁾: 130 W

SURR²⁾: 130 W + 130 W

SURR BACK²⁾³⁾: 130 W + 130 W

SURR BACK²⁾⁴⁾: 130 W

Actual Rated Maximum Output at Stereo Mode¹⁾⁴⁾
(8 ohms, JEITA)

STR-DA5000ES: 220 W + 220 W

Actual Rated Maximum Output at Surround Mode⁴⁾
(8 ohms, JEITA)

STR-DA5000ES: FRONT²⁾: 220 W + 220 W

CENTER²⁾: 220 W

SURR²⁾: 220 W + 220 W

SURR BACK²⁾: 220 W + 220 W

Models of area code CEL, CN, KR:

POWER OUTPUT

Rated Power Output at Stereo Mode¹⁾

(8 ohms 1 kHz, THD 0.7%)

STR-DA5000ES: 170 W + 170 W

STR-DA3000ES: 150 W + 150 W

Reference Power Output at Stereo Mode

(4 ohms 1 kHz, THD 0.7%)

STR-DA5000ES: 150 W + 150 W

STR-DA3000ES: 130 W + 130 W

Reference Power Output

(8 ohms 1 kHz, THD 0.7%)

STR-DA5000ES: FRONT²⁾: 170 W + 170 W

CENTER²⁾: 170 W

SURR²⁾: 170 W + 170 W

SURR BACK²⁾: 170 W + 170 W

STR-DA3000ES: FRONT²⁾: 150 W + 150 W

CENTER²⁾: 150 W

SURR²⁾: 150 W + 150 W

SURR BACK²⁾: 150 W

(4 ohms 1 kHz, THD 0.7%)

STR-DA5000ES: FRONT²⁾: 150 W + 150 W

CENTER²⁾: 150 W

SURR²⁾: 150 W + 150 W

SURR BACK²⁾: 150 W + 150 W

STR-DA3000ES: FRONT²⁾: 130 W + 130 W

CENTER²⁾: 130 W

SURR²⁾: 130 W + 130 W

SURR BACK²⁾: 130 W

Actual Rated Maximum Output at Stereo Mode¹⁾

(8 ohms, JEITA)

STR-DA5000ES: 220 W + 220 W

STR-DA3000ES: 200 W + 200 W

Actual Rated Maximum Output at Surround Mode

(8 ohms, JEITA)

STR-DA5000ES: FRONT²⁾: 220 W + 220 W

CENTER²⁾: 220 W

SURR²⁾: 220 W + 220 W

SURR BACK²⁾: 220 W + 220 W

W

STR-DA3000ES: FRONT²⁾: 200 W + 200 W
 CENTER²⁾: 200 W
 SURR²⁾: 200 W + 200 W
 SURR BACK²⁾: 200 W + 200 W

- 1) Depending on the sound field settings and the source, there may be no sound output.
- 2) Measured under the following conditions:

Area code	Power requirements
U, CA	120 V AC, 60 Hz
TW	110 V AC, 60 Hz
CEL	230 V AC, 50/60 Hz
CN	220-230 V AC, 50/60 Hz
KR	220 V AC, 60 Hz

- 3) Models of area code U, CA only.
- 4) Models of area code TW only.

Frequency response

PHONO	RIAA equalization curve ±0.5 dB
MULTI CHANNEL INPUT 1, 2, CD/ SACD, TAPE, MD/ DAT, DVD, TV/SAT, VIDEO 1, 2, 3	10 Hz – 40 kHz ±3 dB (when sound field and equalizer bypassed)

Inputs (Analog)

PHONO	S/N: 86 dB
MULTI CHANNEL INPUT 1, 2, CD/ SACD, TAPE, MD/ DAT, DVD, TV/SAT, VIDEO 1, 2, 3	S/N: 96 dB

Inputs (Digital)

CD/SACD, DVD (Coaxial)	S/N: 96 dB (A, 20 kHz LPF)
CD/SACD, DVD, TV/ SAT, MD/DAT, VIDEO3 (Optical)	S/N: 96 dB (A, 20 kHz LPF)

Outputs

TAPE, MD/DAT (REC OUT), VIDEO 1, 2 (AUDIO OUT)	
FRONT L/R, CENTER, SURROUND L/R, SURROUND BACK (L/R), SUB WOOFER	
EQUALIZER	
Gain levels	±10 dB, 1 dB step

FM tuner section

Tuning range	87.5 – 108.0 MHz
Antenna	FM wire antenna
Antenna terminals	75 ohms, unbalanced
Sensitivity	
Mono:	18.3 dBf, 2.2 µV/75 ohms
Stereo:	38.3 dBf, 22.5 µV/75 ohms
Useable sensitivity	11.2 dBf, 1 µV/75 ohms
S/N	
Mono:	76 dB
Stereo:	70 dB
Harmonic distortion at 1 kHz	
Mono:	0.3%
Stereo:	0.5%
Separation	45 dB at 1 kHz
Frequency response	30 Hz – 15 kHz, +0.5/–2 dB
Selectivity	60 dB at 400 kHz

AM tuner section

Tuning range	
Models of area code U, CA:	530 – 1,710 kHz ⁵⁾ (With 10-kHz tuning scale) 531 – 1,710 kHz ⁵⁾ (With 9-kHz tuning scale)
Models of other area codes:	531 – 1,602 kHz (With 9-kHz tuning scale)
Antenna	Loop antenna
Usable sensitivity	50 dB/m (at 1,000 kHz or 999 kHz)
S/N	54 dB (at 50 mV/m)
Harmonic distortion	0.5% (50 mV/m, 400 Hz)
Selectivity	
At 9 kHz:	35 dB
At 10 kHz:	40 dB

- 5) You can change the AM tuning scale to 9 kHz or 10 kHz. After tuning in any AM station, turn off the

receiver. While holding down PRESET TUNING + or TUNING +, press I/⏪. All preset stations will be erased when you change the tuning scale. To reset the scale to 10 kHz (or 9 kHz), repeat the procedure.

Video section

Inputs/Outputs

Video: 1 Vp-p, 75 ohms
 S-video: Y: 1 Vp-p, 75 ohms
 C: 0.286 Vp-p, 75 ohms
 COMPONENT VIDEO: Y: 1 Vp-p, 75 ohms
 P_B/C_B/B-Y: 0.7 Vp-p, 75 ohms
 P_R/C_R/R-Y: 0.7 Vp-p, 75 ohms
 80 MHz HD Pass Through

General

Power requirements

Area code	Power requirements
U, CA	120 V AC, 60 Hz
CEL	230 V AC, 50/60 Hz
TW	110 V AC, 60 Hz
CN	220-230 V AC, 50/60 Hz
KR	220 V AC, 60 Hz

Power consumption

STR-DA5000ES:

Area code	Power consumption
U, CEL, TW, CN	300 W
CA	500 VA

STR-DA3000ES:

Area code	Power consumption
U, CEL, TW, CN, KR	280 W
CA	470 VA

Power consumption (during standby mode)

1 W

AC outlets

Area code	AC outlets
U, CA	2 switched, 120 W/1A MAX
CEL	1 switched, 100 W MAX
CN, KR, TW	– (no AC outlet)

Dimensions 430 × 175 × 470 mm
 including projecting parts and controls

Mass (Approx.) 13 kg

Supplied accessories

FM wire antenna (1)
 AM loop antenna (1)
 AC power cord (1)
 STR-DA5000ES:
 Remote commander RM-LJ312 (1)
 R6 (size-AA) batteries (3)
 STR-DA3000ES:
 Remote commander RM-LG112 (1)
 R6 (size-AA) batteries (2)
 Models of area code U, CA:
 Remote commander RM-US106 (1)
 R6 (size-AA) batteries (2)

For details on the area code of the component you are using, see page 3.

Design and specifications are subject to change without notice.

List of button locations and reference pages

How to use this page

Use this page to find the location of buttons and other parts of the system that are mentioned in the text.

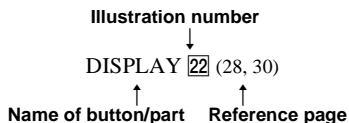

Main unit

ALPHABETICAL ORDER

A.F.D. 6 (33, 34, 36)
BASS 32 (42)
DECODE PRIORITY 23 (43)
Digital Cinema Sound indicator 4
DIMMER indicator (STR-DA3000ES only) 13
DIRECT 24 (36)
DIRECT indicator 2
DISPLAY 22 (28, 30)
Display 3 (30)
FM/AM 19 (26)
Input indicators (STR-DA5000ES only) 13
INPUT MODE 11 (39)
INPUT SELECTOR 10 (24, 25, 26, 27, 28, 39, 49)
IR receptor 14
MAIN MENU 30 (19, 25, 30, 38, 39, 40, 41, 42, 47, 48, 49)
MASTER VOLUME 9 (24)
MEMORY/ENTER 20 (27, 38, 49)
MENU 29 (19, 25, 30, 38, 39, 40, 41, 42, 47, 48, 49)
MOVIE 7 (34)
MULTI CH IN 1/2 25 (25)
MULTI CHANNEL DECODING indicator 12
MUSIC 8 (35, 40)
PHONES jack 15
PRESET TUNING -/+ 17 (27)
SPEAKERS switch 16 (50)
SURR BACK DECODING 26 (36)
TREBLE 31 (42)
TUNING -/+ 18 (25)
USER PRESET 21 (48)
VIDEO 3 INPUT jacks 27 (14)

NUMBERS AND SYMBOLS

2CH 5 (33)
I/⏻ (power) 1
-/+ 28 (19, 25, 38, 39, 40, 41, 42, 47, 48, 49)

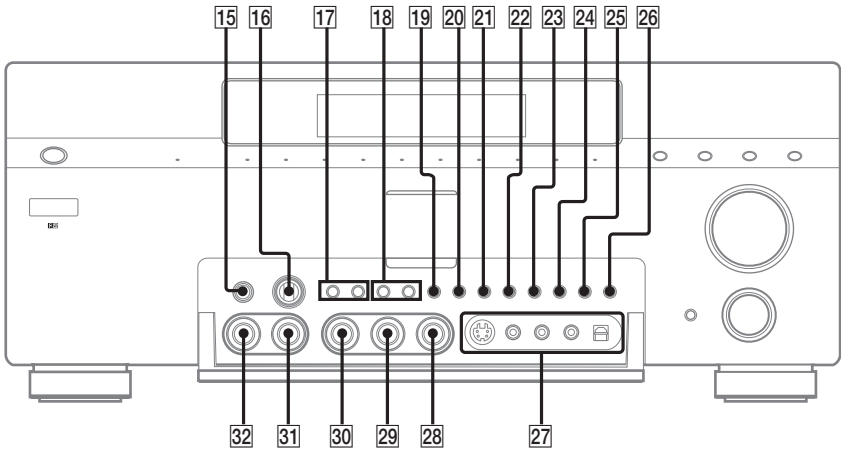
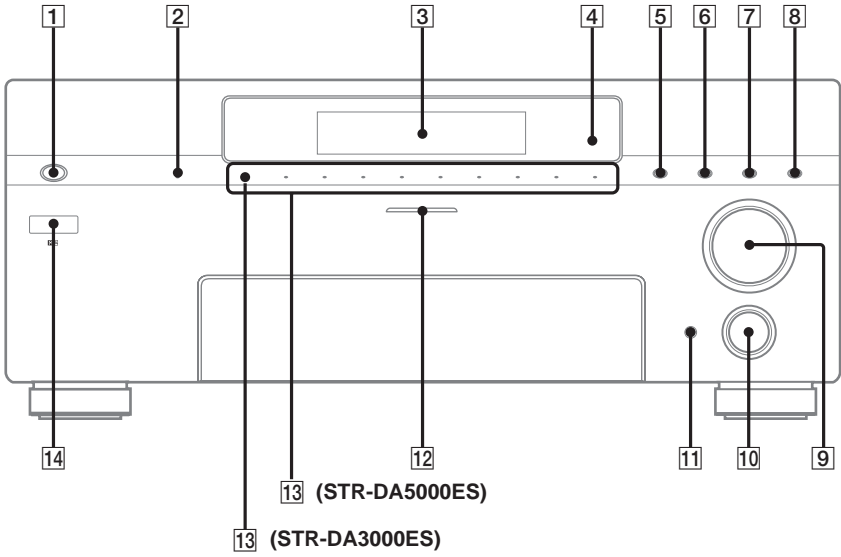

Index

A

Adjusting

- CIS parameters 47
- CUSTOMIZE parameters 42
- EQUALIZER parameter 41
- LEVEL parameter 40, 46
- SPEAKER SET UP parameters 19, 44
- speaker volume 22
- SURR SET UP parameters 39

Automatic tuning 25

C

Changing

- display 30
- effect level 39

CIS 47

CIS menu 47

Clearing receiver's memory 18

CONTROL A1 II 54

Crossover frequency 45

CUSTOMIZE menu 42

D

Digital Cinema Sound 34

Direct tuning 26

Dubbing. *See* Recording

E

Editing. *See* Recording

Effect level 39

EQUALIZER menu 41

I

Indexing. *See* Naming

L

Labeling. *See* Naming

LEVEL menu 46

N

Naming 49

P

Preset stations

- how to 27
- how to tune 27

R

RDS 28

Recording

- on a video tape 51
- on an audio tape or MD 51

S

Selecting

- component 24
- front speaker system 50
- sound field 34–35

Sleep Timer 50

Sound field

- customizing 39
- pre-programmed 34–35
- resetting 40
- selecting 34–35

SPEAKER SET UP menu 19, 44

Speakers

- adjusting speaker volume 22
- connection 16
- impedance 17
- placement 16

Supplied accessories 62

SURR SET UP menu 39, 45

T

Test tone 22

TUNER menu 25, 49

Tuning

- automatically 25
- directly 26
- preset stations 27

